



SCC1800A

Crawler Crane 180 Tons Lifting Capacity

Quality Changes the World



- Max. lifting moment: $132 \times 8 = 1056t \cdot m$**
- Max. boom length: 82m**
- Max. fixed jib combination: 70m+31m**
- Max. luffing jib combination: 52m+52m**

The parameters, pictures and standard/optional equipment are only for reference in this brochure, the actual machine is based on the effective price list and contract.



Crawler Crane Series
SCC1800A

P03

Main
Characteristics

- Product Specification
- Safety Device

P09

Technical
Parameters

- Major Performance & Specifications
- Outline Dimension
- Transport Dimension
- Transport Plan

P19

Configurations

- H Configuration
- FJ Configuration
- LJ Configuration



SCC1800A
SANY CRAWLER CRANE
180 TONS LIFTING CAPACITY

QUALITY CHANGES THE WORLD

Main Characteristics

- Page 04 Product Specification
- Page 07 Safety Device



Product Specification



Engine

- Model: DCEC (Cummins China) QSL8.9-C325 Diesel engine.
- Type: 4-stroke, water-cooled, vertical in-line 6 cylinders, direct injection, turbo-charger, intercooler, complied with european non-road tier III emission standard and Chinese non-road tier III emission standard.
- Displacement: 8.9L.
- Rated power: 242kW/2100rpm.
- Operation power: 234kW/1800rpm.
- Max. Torque: 1385N·m/1500rpm.
- Starter: 24V-6.0kW.
- Radiator: Fin type aluminum plate core.
- Air cleaner: Dry type system with main filter element, safety element and resistance indicator.
- Throttle: Grip type hand throttle, electrically-controlled.
- Fuel filter: Replaceable paper element.
- Batteries: Two 12V×180Ah capacity batteries, connected in series.
- Fuel tank capacity: 400L.

Electrical control system

- Self-developed SYIC-II integrated control system is adopted with higher integration, precise operation and reliable quality.
- Control system consists of power system, engine system, main control system, LMI system, auxiliary system and safety monitoring system. CAN BUS is used for data communication between controller, monitor and the engine.
- Monitor: The working parameters and status are shown on the monitor, such as the engine speed, fuel volume, engine oil pressure, servo pressure, engine working hours, lifting conditions and boom angle.

Hydraulic system

- Main pumps: Open variable displacement piston pumps of large displacement are adopted to provide oil supply for main actuators of main machine.
- Gear pump: Dual gear pump for radiator and control circuit.
- Control: Main pump adopts electrically-controlled positive flow control; winch motor adopts limitless adjustable piston motor of variable displacement. The operating components are two cross hydraulic handle, one dual travel pedal control valve to control various actuators proportionally.
- Way of cooling: Heat exchanger, fan core and multi-stage cooling.
- Filter: Large flow, high precision filter, with bypass valve and transmitter, which can remind the user to replace the filter element in time.
- Max. pressure of system: 32Mpa.
- Main/aux. load hoist, boom hoist, slewing and travel system: 32Mpa.
- Control system: 5MPa.
- Hydraulic tank capacity: 460L.

Main and auxiliary load hoist mechanism

- Main and aux. hoist winches are driven separately by motor via gearbox. Operating winch handle can control the winch to rotate to two directions, which are lifting and lowering of hook. Excellent inching function is equipped on the machine.
- Drums with fold-line grooves can ensure the wire rope reeved in order in multilayers.

Main hoisting mechanism	Drum diameter	630mm
	Rope speed (5th layer)	0-130m/min
	Diameter of wire rope	26mm
	Main load hoist wire rope length	390m
	Rated single line pull	13.5t
Auxiliary hoisting mechanism	Drum diameter	630mm
	Rope speed (5th layer)	0-130m/min
	Diameter of wire rope	26mm
	Auxiliary load hoist wire rope length	300m
	Rated single line pull	13.5t



Product Specification

Boom hoist mechanism

- Boom hoist winch is driven directly by motor via gearbox. Operating winch handle can control the winch to rotate to two directions, which are lifting and lowering of boom.
- Drums with fold-line grooves can ensure the wire rope reeved in order in multilayers.

Boom hoist mechanism	Drum diameter	440mm
	Rope speed (5th layer)	0~46m/min
	Diameter of wire rope	22mm
	Boom hoist wire rope length	250m
Jib hoist mechanism	Drum diameter	500mm
	Rope speed (5th layer)	0~46m/min
	Diameter of wire rope	22mm
	Jib hoist wire rope length	190m

Slewing mechanism

- Slewing brake adopts wet, spring loaded, normally-closed brake, and braking through spring force.
- Slewing system, has free slipping function. It is featured in steady starting and control, and excellent inching function. Unique slewing buffer design and steadier brake.
- Slewing drive: Internal engaged slewing drive with 360° slewing range, and the max. slewing speed is 1.3r/min. The max. drive pressure can reach 32MPa.
- Slewing ring: Three-row roller bearing.

Cab and control

- Novel operator's cab with fashionable profile, nice interior and large window glass, which can shift horizontally and tilt up and down. There are low and high-beam lights, back-view mirror, heater and A/C, radio and other functions. The layout of seat, handles, control buttons are designed with ergonomic principles to make operation more comfortable.
- Cab layout: Integrated 10.4-inch touch screen, programmable smart switches, and man-machine interaction interface are more perfect.
- Armrest box: On the left and right armrest box are control handles, electrical switches, emergent stop and ignition switch. The armrest box can be adjusted along with the seat.
- Seat: Multi-way and multi-level floating adjustable seat with unload switch.
- A/C: Cool and heat air; optimized air channels and vents.
- Multiple cameras can present on the monitor at the same time to realize backing video, real-time monitoring of wire rope on each winch, conditions behind the counterweight and surrounding the machine.

Counterweight

- The stacking mode of counterweight tray and blocks is used for easy assembly, disassembly and transportation.
- Rear counterweight: Total weight 68t. There are two types, one is regular counterweight as standard offering ; and self-assembly counterweight as optional offering. Counterweight block 6t×8, counterweight block 3t×2, and counterweight tray of 14t.
- Carbody counterweight: Total weight 25t, 12.5t×2.

Upperworks

- High-strength steel weld framework, with no torsion or deformation. The parts are laid out in the way that is easier for maintenance and service.

Product Specification



Lowerworks

- Independent travel driving units are adopted for each side of the crawler, to realize straight walking and turning driven by travel motor through gearbox and drive wheel.

Crawler tightening

- The jack is used to push the guide wheel and insert the shim to adjust crawler tension.

Track pad

- High strength alloy cast steel track pad ensure long service life.
- The track pads are 1100mm wide, a total of 70 pcs ×2.

Operating equipment

- All chords are high-strength steel tubes, and the boom/jib top sheaves are made of high-strength anti-wearing Nylon material protecting wire rope. The hooks are installed with milled welded steel sheave.

Boom

- Lattice structure. The chord adopts high-strength structural tube and each section is connected through pins.
- Basic boom: 8m boom base + 8m boom top.
- Boom insert: 3m×2, 6m×2, 12m×4.
- Boom length: 16m~82m.

Fixed jib

- Lattice structure. The chord adopts high-strength structural tube and each section is connected through pins.
- Basic jib: 5m jib base +3m insert +5m jib top.
- Jib insert: 6m×3.
- Fixed jib: 13m~31m.
- Longest boom + jib: 70m +31m.

Luffing jib

- Lattice structure. The chord adopts high-strength structural tube and each section is connected through pins.
- Basic jib: 6.5m jib base +9m insert +6.5m jib top.
- Jib insert: 3m×2, 6m×1, 9m×2.
- Longest boom + jib: 52m +52m.

Extension jib

- The welding structure is connected with main boom through hinge pin, and used for aux. hook operation.
- Length of extension boom: 1.5m.

Hook block

- 180t hook, 7 pulleys.
- 100t Hook, 5 pulleys.
- 50t Hook, 3 pulleys.
- 13.5t, ball hook.

Hook limitation height

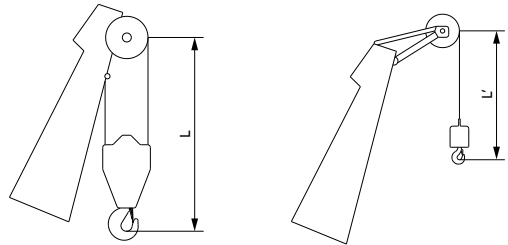

Hook	L
180t	4.2m
100t	4.1m
50t	3.9m

Hook	L'
13.5t	3.3m

Safety Device



Assembly/work mode control switch

- Under the assembly mode, over-hoist limit switch, crane boom limit device and load moment limiter do not work, so as to facilitate the installation of crane.
- All safety limit devices work in the work mode.

Emergency stop

- In emergent situation, this button is pressed down to cut off the power supply of whole machine and all actions stop.

Load moment limiter (LMI)

- It is an independent computerized safety control system. LMI can automatically detect the load weight, work radius and boom angle, and present on the display the rated load, actual load, work radius and boom angle. In normal operation, the LML can make a judgment and cut off automatically if the crane moves towards dangerous direction. It can also perform as a black box to record the lifting information.
- It is composed of monitor, angle sensor and force sensor and other parts.

Over-hoist limit switch of main/auxiliary hooks

- Over-hoist protection device comprises of limit switch and weight on boom top, which prevents the hook lifting up too much.
- When the hook lifts up to the limit height, the limit switch activates, buzzer on the left control panel sends alarm, failure indicator light starts to flash, and the hook hoisting action is cut off automatically.

Over-release limit switch of main/auxiliary hooks

- It is comprised of activator in the drum and proximity switch to prevent over release of wire rope. When the rope is paid out close to the last three wraps, the limit switch acts, and the system sends alarm through buzzer and show the alarm on the instrument panel, automatically cutting off the winch action.

Function lock lever

- If the function lock lever is not in work position, all the other handles won't work, which prevents any mis-operation caused by accidental collision.

Boom hoist drum lock

- Pawl lock is used on boom hoist winch, which needs to unlock by switch before operation, in order to prevent mis-operation of handles and ensure safety during nonwork time.

Slewing lock device

- Slewing Lock can lock the machine at four positions, front and back, left and right.

Boom limit device

- When the boom elevation angle reaches the max. set limit, the buzzer sounds and boom action cut off. This protection is two-stage control ensured by both LML system and travel switch.

Back-stop device

- Its major components are nesting tubes and spring, in order to buffer the boom backlash and prevent further tipping back.

Boom angle indicator

- Pendulum angle indicator is fixed on the side of boom base close to the cab, so as to provide convenience to the operator.

Hook latch

- The hook is provided with a baffle to prevent wire rope from falling off.

Safety Device



Lightning protection device

- It is offered as an optional feature, which includes the grounding device that can effectively protect the electric system elements and workers from lightning.

Tri-color load indicator

- The load indication light has three colors, green, yellow and red, and the real time load status is presented on the display. When the actual load is smaller than 90% of rated load, the green light is on.
- When the actual load is larger than 90% and smaller than 100%, the yellow light is on, the alarm light flashes and sends out intermittent sirens.
- When the actual load reaches 100% of rated load, the red light is on, the alarm light flashes and sends out continuous sirens.
- When the actual load reaches 102% of rated load, the system will automatically cut off the crane operation in dangerous trend.

Audio-visual alarm

- When the engine is working, the light flashes; when the machine is traveling or swinging, it sends out sirens.

Slewing indicator light

- The slewing indicator light flashes during traveling or slewing.

Illuminating light

- The machine is equipped with the low beam light and high beam light at the front of the cab, illumination light at cab, and other night lights, boom lights to improve the visibility during construction.

Camera

- Set on the handrail at the front of right sheet metal, so as to monitor the rear part of machine.

Pharos

- Pharos is mounted on the top of boom/jib to indicate the height.

Anemometer

- It is mounted on the top of boom/jib, and displayed on the monitor in the cab.

Electronic level indicator

- It displays the tipping angle of crane on the monitor in real time, protecting the machine from dangerous situation.

Seat interlock

- Put down the function lock lever on the left side of cab seat or if the operator leaves the seat, all control levers will be deactivated to prevent any mis-operation due to accidental collision.

Engine power limit load adjustment and stalling protection

- The controller monitors the engine power to prevent engine getting stuck and stalling.

Engine status monitoring

- The engine status will be presented, such as engine coolant temperature, fuel volume, total work hours, engine oil pressure, engine speed, battery charging, voltage.



SCC1800A
SANY CRAWLER CRANE
180 TONS LIFTING CAPACITY

QUALITY CHANGES THE WORLD

Technical Parameters

- Page 10 Major Performance Specifications
- Page 11 Outline Dimension
- Page 12 Transport Dimension
- Page 17 Transportation Plan



Major Performance Specifications

Major Performance & Specifications of SCC1800A			
Performance Indicators		Unit	Parameter
Boom configuration	Maximum rated lifting capacity	t	180
	Maximum rated lifting moment	t·m	1056 (=132×8)
	Boom length	m	16~82
Fixed jib configuration	Maximum rated lifting capacity	t	34
	Jib length	m	13~31
	Longest main boom + jib	m	70+31
Luffing jib configuration	Maximum rated lifting capacity	t	61.3
	Jib length	m	22~52
	Longest main boom + luffing jib	m	52+52
Operation speed	Rope speed of main/aux. load hoist (5th layer)	m/min	0~130
	Boom hoist winch rope speed (5th layer)	m/min	0~46
	Slewing speed	rpm	0~1.3
	Travelling speed	km/h	0~1
Engine	Output power	kW	242
	Rated speed	rpm	2100
Transport parameter	Max. transport weight of basic machine (with boom base)	t	45
	Maximum transport dimension of basic machine (L x W x H, mm)	mm	17500×3000×3250
Other parameters	Average ground bearing pressure	MPa	0.118
	Grade ability	%	30

Outline Dimension

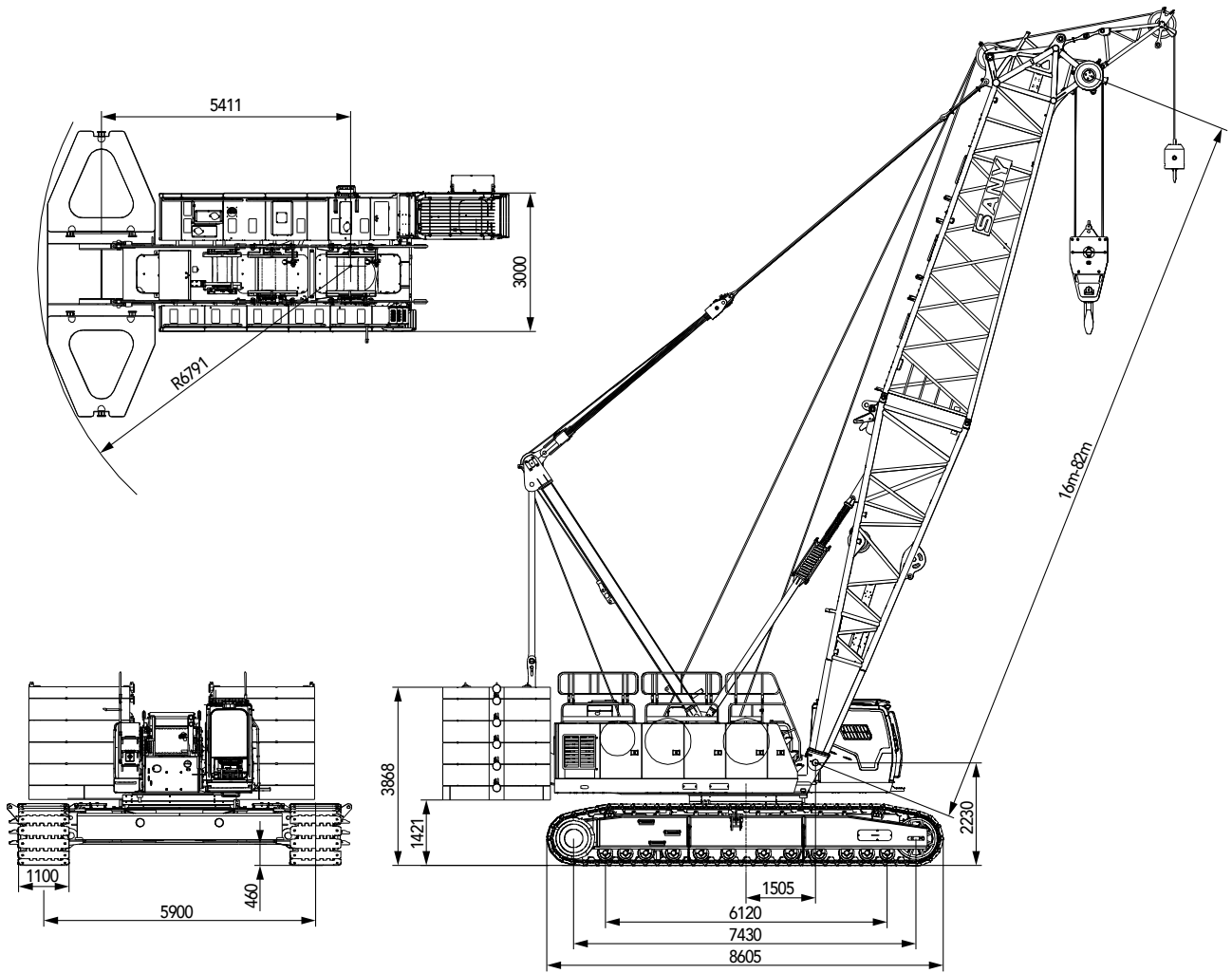

Transportation Dimensions

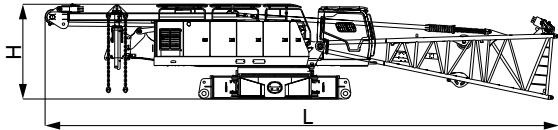

Basic machine (mode 1: with boom base, no reeving winch or jib luffing winch) ×1

Length (L)	17.5m
Width (W)	3.00m
Height (H)	3.25m
Weight	43.2t

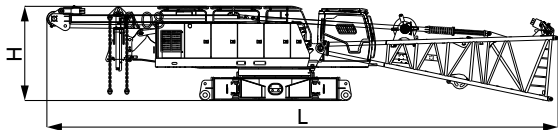

Basic machine (mode 2: with boom base, optional reeving winch and jib luffing winch) ×1

Length (L)	17.5m
Width (W)	3.00m
Height (H)	3.25m
Weight	45.0t

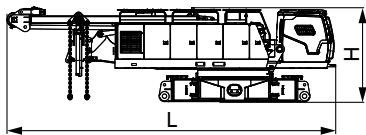

Basic machine (mode 3: excluding boom base) ×1

Length (L)	11.3m
Width (W)	3.00m
Height (H)	3.25m
Weight	40.8t

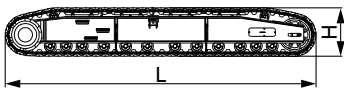

Crawler assembly ×2

Length (L)	8.59m
Width (W)	1.44m
Height (H)	1.32m
Weight	18.38t

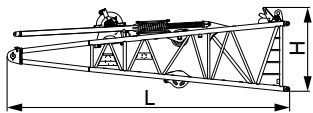

Boom base (with jib luffing winch) ×1

Length (L)	8.24m
Width (W)	2.37m
Height (H)	2.44m
Weight	5.44t

Note: the weight of jib luffing winch is 1.25t

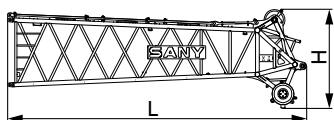

Boom top ×1

Length (L)	8.77m
Width (W)	2.22m
Height (H)	2.91m
Weight	3.06t

Transport Dimensions

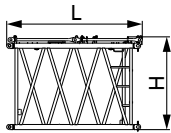

3m boom insert × 2

Length (L)	3.18m
Width (W)	2.27m
Height (H)	2.17m
Weight	0.79t

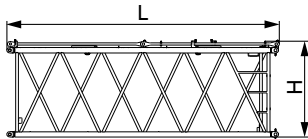

6m boom insert × 2

Length (L)	6.18m
Width (W)	2.27m
Height (H)	2.17m
Weight	1.27t

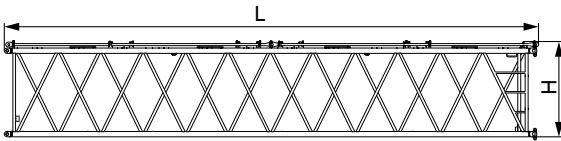

12m boom insert × 4

Length (L)	12.18m
Width (W)	2.27m
Height (H)	2.17m
Weight	2.36t

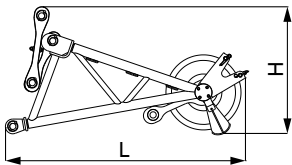

Extension jib × 1

Length (L)	1.96m
Width (W)	0.76m
Height (H)	1.03m
Weight	0.24t

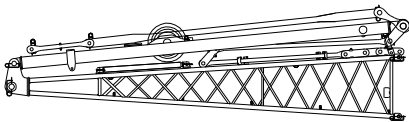

Fixed jib base (with strut and tapered pendant strap) × 1

Length (L)	5.19m
Width (W)	2.16m
Height (H)	1.66m
Weight	1.12t

Note: the weight of the strut is 0.44t, and the tapered pendant strap is 0.11t

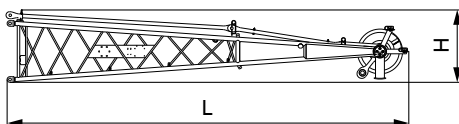

Fixed jib top × 1

Length (L)	5.43m
Width (W)	1.01m
Height (H)	0.99m
Weight	0.53t

Transport Dimensions

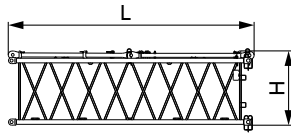

3m fixed jib insert

×1

Length (L)	3.12m
Width (W)	1.02m
Height (H)	0.92m
Weight	0.19t

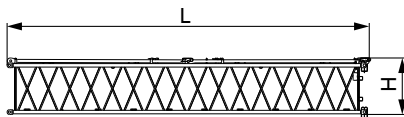

6m fixed jib insert

×3

Length (L)	6.12m
Width (W)	1.02m
Height (H)	0.92m
Weight	0.34t

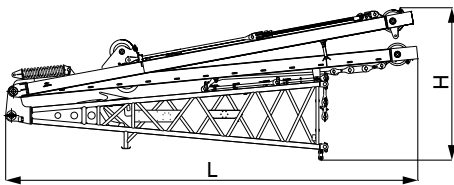

Luffing jib base (with strut)

×1

Length (L)	8.55m
Width (W)	2.19m
Height (H)	3.16m
Weight	4.5t

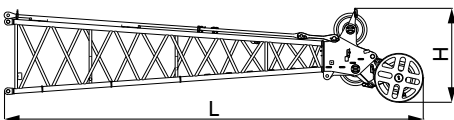

Luffing jib top (with extension jib)

×1

Length (L)	7.75m
Width (W)	1.61m
Height (H)	1.85m
Weight	1.5t

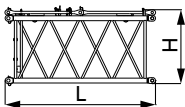

3m luffing jib insert

×2

Length (L)	3.14m
Width (W)	1.61m
Height (H)	1.54m
Weight	0.48t

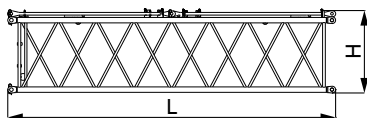

6m luffing jib insert

×1

Length (L)	6.14m
Width (W)	1.61m
Height (H)	1.54m
Weight	0.79t

Transport Dimensions

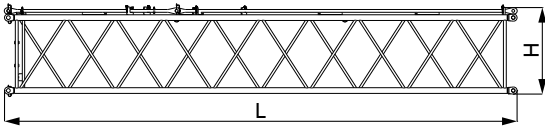

9m luffing jib insert

× 3

Length (L)	9.14m
Width (W)	1.61m
Height (H)	1.54m
Weight	1.08t

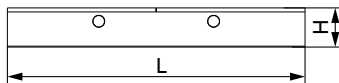

Carbody counterweight

× 2

Length (L)	4.55m
Width (W)	1.45m
Height (H)	0.79m
Weight	12.5t

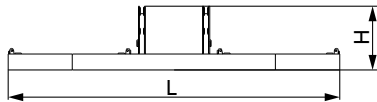

Counterweight tray for regular counterweight (standard offering)

× 1

Length (L)	6.2m
Width (W)	2.33m
Height (H)	1.2m
Weight	14.0t

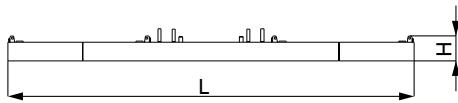

Counterweight tray for self-assembly counterweight (optional offering)

1

Length (L)	6.52m
Width (W)	2.33m
Height (H)	0.52m
Weight	14.0t

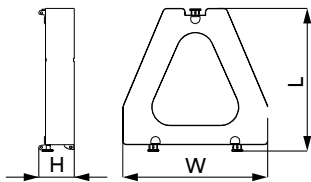

Counterweight block 1

× 8

Length (L)	2.29m
Width (W)	2.33m
Height (H)	0.57m
Weight	6.0t

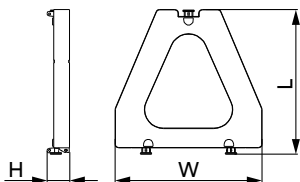

Counterweight block 2

× 2

Length (L)	2.29m
Width (W)	2.33m
Height (H)	0.35m
Weight	3.0t

Transport Dimensions

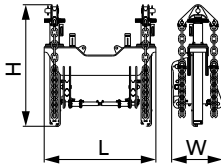

Self-assembly counterweight bracket (optional, with cylinder and chains) ×1

Length (L)	2.02m
Width (W)	0.92m
Height (H)	2.20m
Weight	1.82t

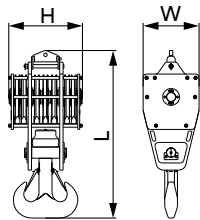

180t hook ×1

Length (L)	2.45m
Width (W)	0.82m
Height (H)	1.08m
Weight	2.95t

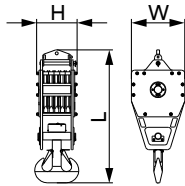

100t hook ×1

Length (L)	2.36m
Width (W)	0.93m
Height (H)	0.84m
Weight	1.99t

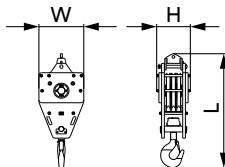

50t hook ×1

Length (L)	1.95m
Width (W)	0.89m
Height (H)	0.47m
Weight	1.06t

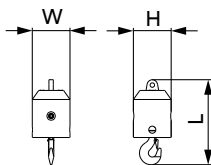

13.5t ball hook ×1

Length (L)	0.95m
Width (W)	0.43m
Height (H)	0.43m
Weight	0.45t

Remarks:

- 1.The transport dimensions for the parts are for reference that do not draw to the scale. The dimensions listed above are designed values excluding packing.
- 2.Weight is design values. It maybe different due to manufacturing tolerances.

Transport Plan

Trailer 1	<ul style="list-style-type: none"> 50t low deck trailer, 13.5m long, 3m wide
Part (s)	<ul style="list-style-type: none"> Basic Machine (with four winches, carbody assembly, A-frame, wire rope) 39.53t Boom base (include jib hoist winch and jib hoist wire rope) 5.44t Boom base outer pendant strap 0.03t
Weight	<ul style="list-style-type: none"> Total: 45t

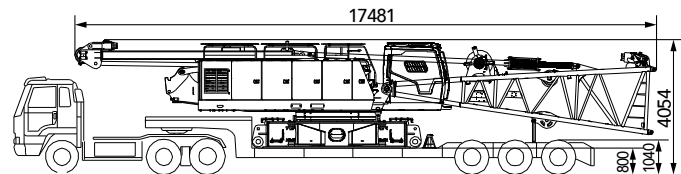

Trailer 2	<ul style="list-style-type: none"> 30t trailer, 17.5m long, 3m wide
Part (s)	<ul style="list-style-type: none"> boom top 3.06t Extension jib 0.24t Luffing jib base with struts 4.5t 180t hook block, 2.95t 100t hook block, 1.99t Boom top outer pendant bar 0.24t Packing case 1t
Weight	<ul style="list-style-type: none"> Total: 13.98t

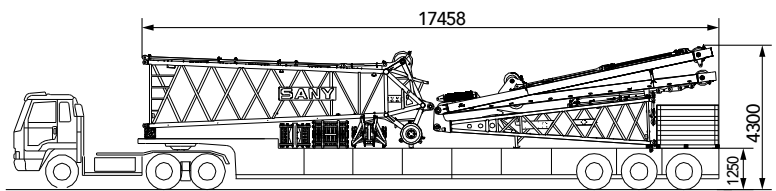

Trailer 3	<ul style="list-style-type: none"> 35t trailer, 17.5m long, 3m wide
Part (s)	<ul style="list-style-type: none"> 12m boom insert, 2.36t 6m boom insert, 1.27t 9m luffing jib insert, 1.08t 3m luffing jib insert, 0.48t 6m fixed jib insert, 0.34t Rear counterweight 1x4, 24t 50t hook block, 1.06t 13.5t ball hook, 0.45t
Weight	<ul style="list-style-type: none"> Total: 31.04t

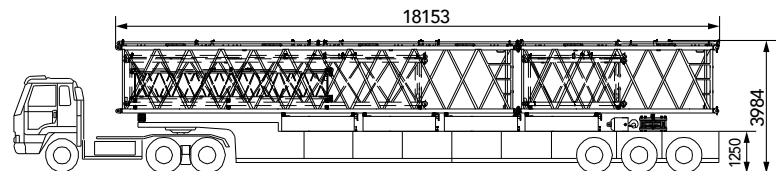

Trailer 4	<ul style="list-style-type: none"> 35t trailer, 17.5m long, 3m wide
Part (s)	<ul style="list-style-type: none"> 12m boom insert, 2.36t 6m boom insert, 1.27t 9m luffing jib insert, 1.08t 3m luffing jib insert, 0.48t 6m fixed jib insert, 0.34t Rear counterweight 1x4, 24t 12m boom outer pendant strap, 0.34t 6m boom outer pendant strap, 0.19t
Weight	<ul style="list-style-type: none"> Total: 30.06t

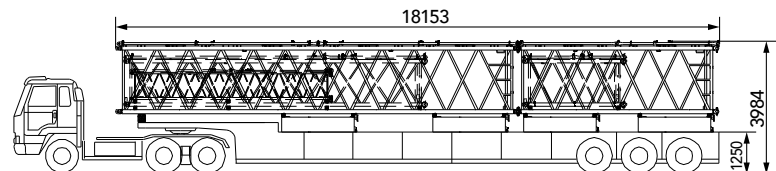

Transport Plan

Trailer 5	<ul style="list-style-type: none"> 35t trailer, 17.5m long, 3m wide
Part (s)	<ul style="list-style-type: none"> 12m boom insert: 2.36t 3m boom insert: 0.79t 9m luffing jib insert: 1.08t 6m fixed jib insert: 0.34t Rear counterweight tray: 14t Tapered pendant strap: 0.11t 12m boom outer pendant strap: 0.34t 3m boom outer pendant strap: 0.11t
Weight	<ul style="list-style-type: none"> 19.13t

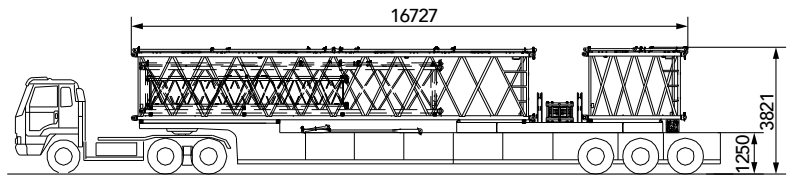

Trailer 6	<ul style="list-style-type: none"> 35t trailer, 17.5m long, 3m wide
Part (s)	<ul style="list-style-type: none"> 12m boom insert: 2.36t 3m boom insert: 0.79t 6m luffing jib insert: 0.79t Fixed jib base with strut without tapered pendant bar: 1.01t Fixed jib top: 0.53t 3m fixed jib insert: 0.19t Carbody counterweight x2: 25t Rear counterweight 2x2: 6t 3m boom outer pendant strap: 0.11t
Weight	<ul style="list-style-type: none"> 36.78t

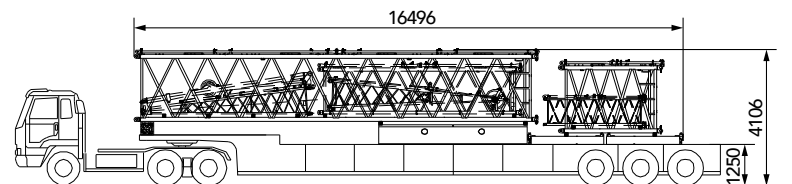

Trailer 7	<ul style="list-style-type: none"> 45t trailer, 17.5m long, 3m wide
Part (s)	<ul style="list-style-type: none"> Left and right track frame (stagger the position): 39t Luffing jib top with extension jib: 1.5t
Weight	<ul style="list-style-type: none"> 40.5t

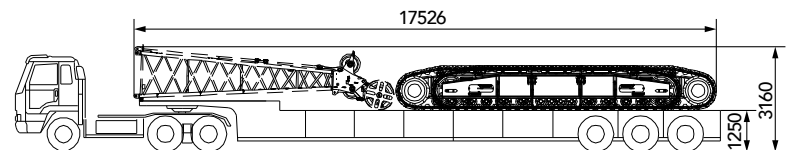

Note: The transport plan is for crane with regular counterweight of standard offering.



SCC1800A
SANY CRAWLER CRANE
180 TONS LIFTING CAPACITY

QUALITY CHANGES THE WORLD

Configurations

- Page 21 H Configuration
- Page 25 FJ Configuration
- Page 35 LJ Configuration

> 19

Boom Combination

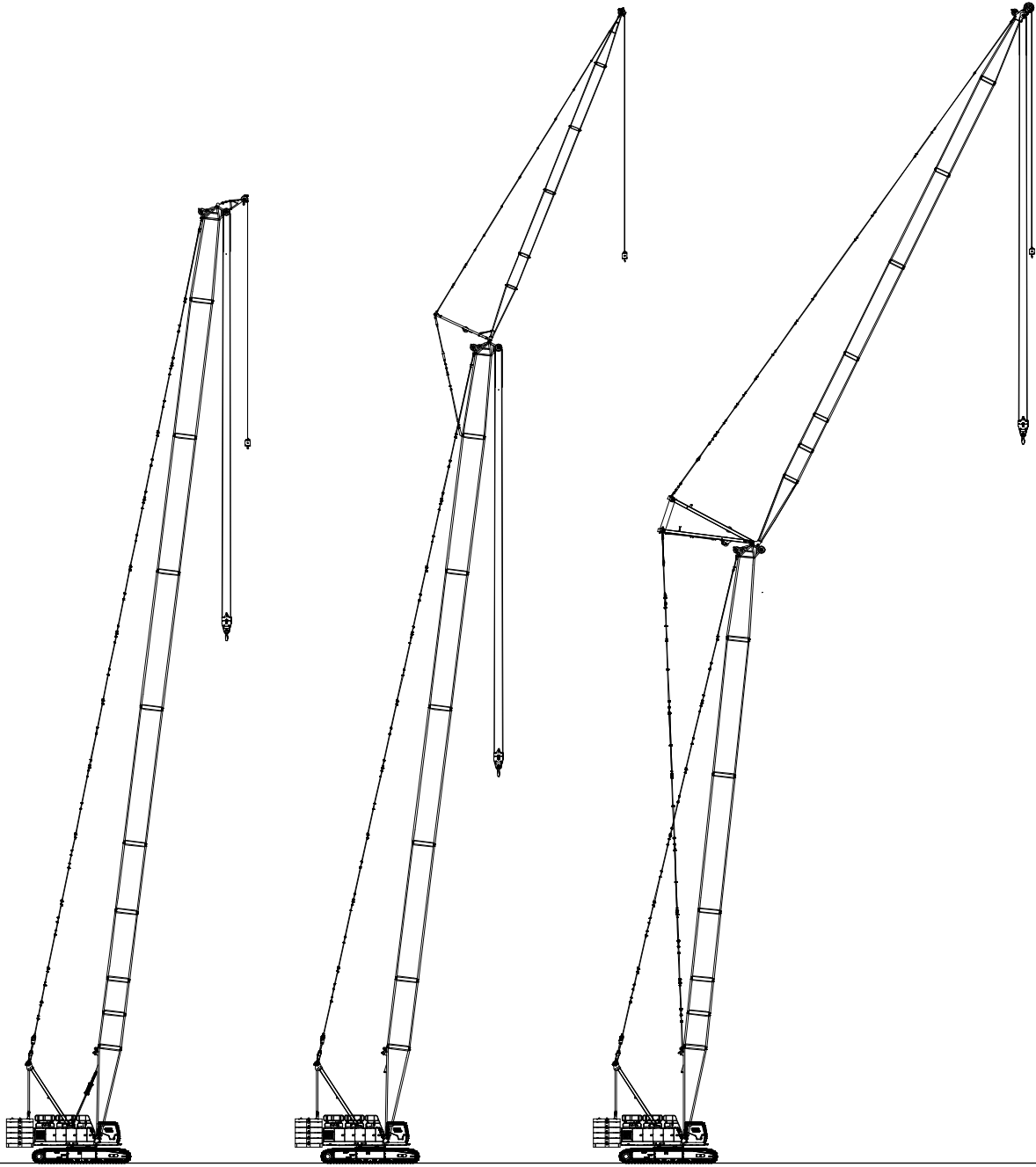

H configuration

FJ configuration

LJ configuration

H Configuration

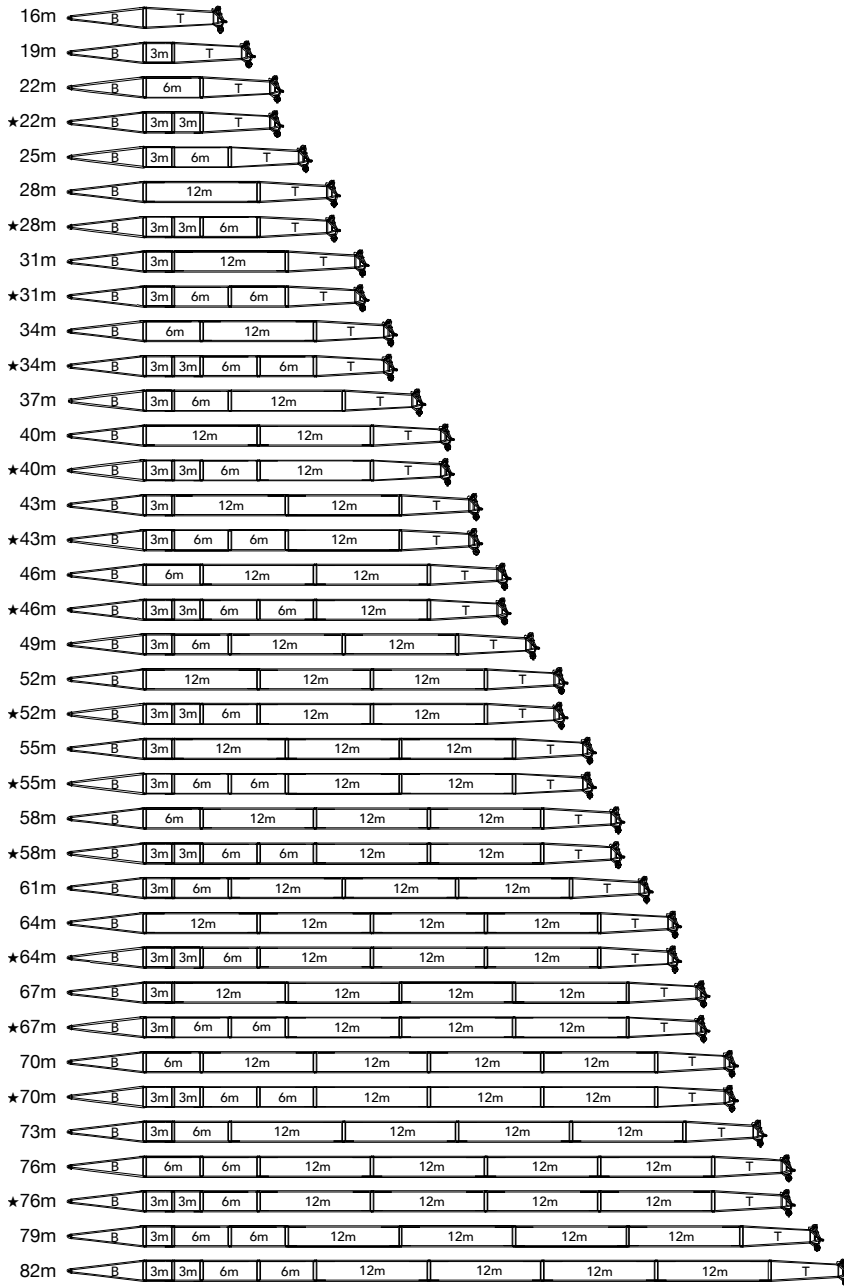

Note: ★ means recommended boom combination for purchasing.

	8m	Boom base
	8m	Boom top
	3m	Boom insert
	6m	Boom insert
	12m	Boom insert

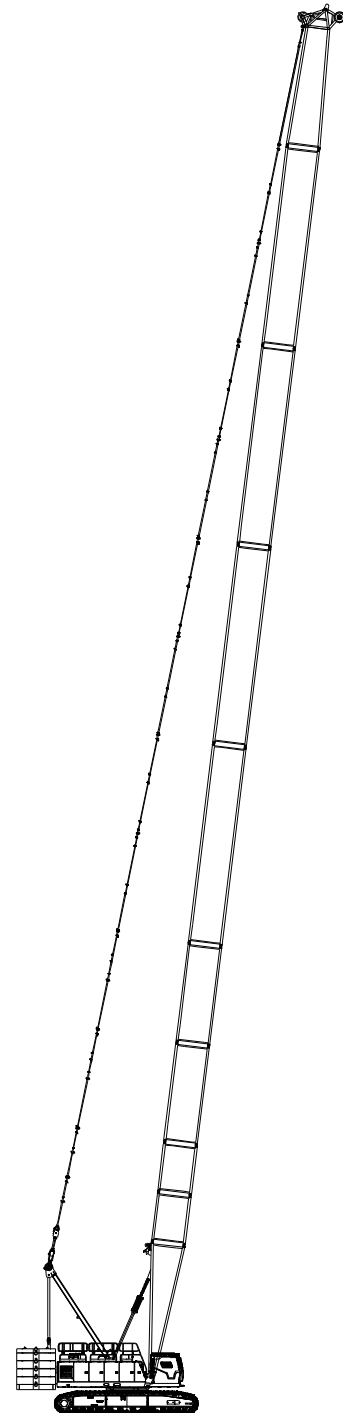

H configuration

H Working Radius

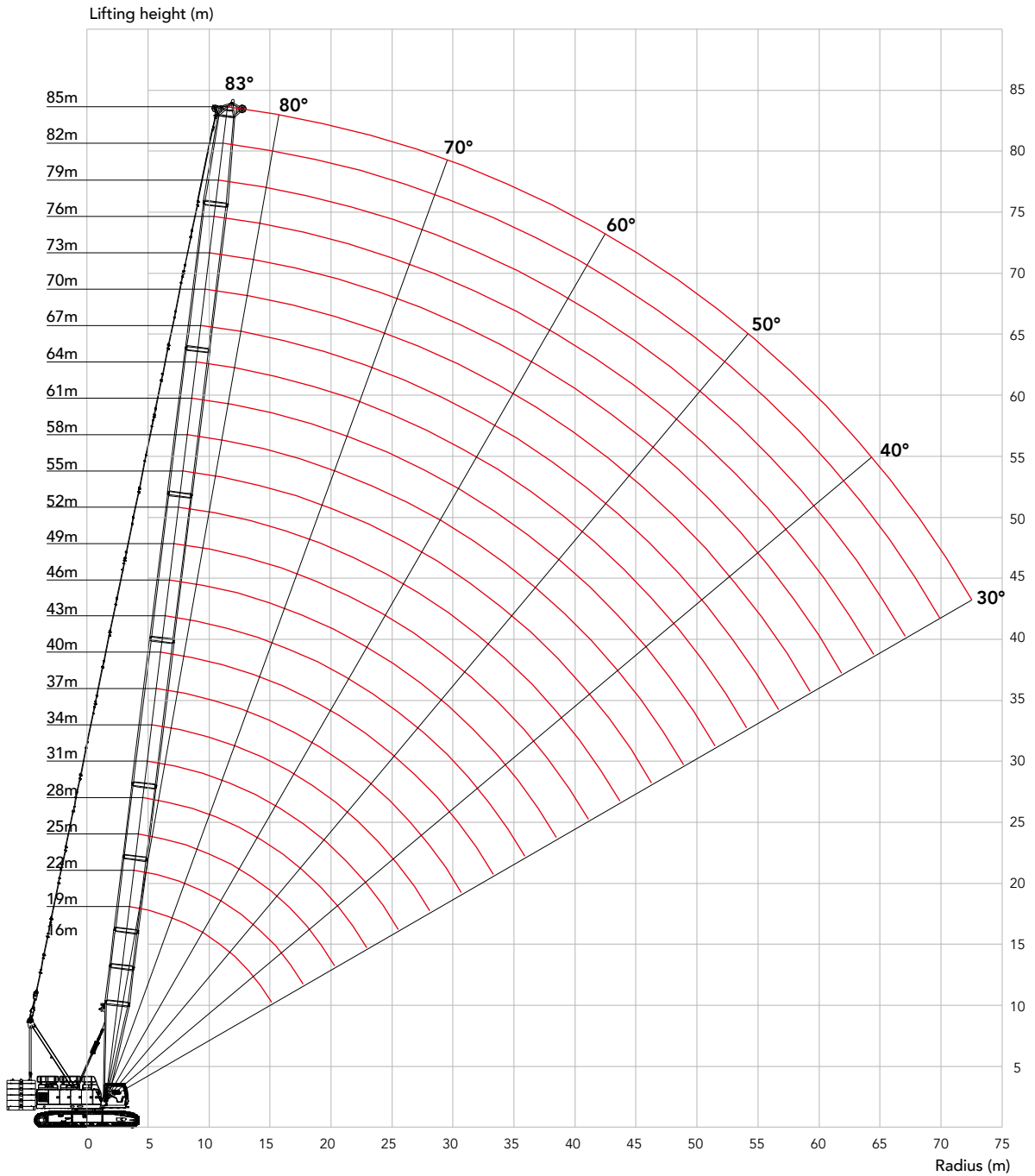

H Load Chart

Note:

- 1.The rated load in the load chart is calculated complying with EN 13000;
- 2.The working radius is the horizontal distance from the load center to the slewing center;
- 3.The actual lifting capacity must subtract the weight of hooks and other riggings from the rated capacity in the load chart.
- 4.The load value is calculated when the object is hung freely,without considering the influence of wind on the load, ground conditions and slope, operation speed and the influence of any other negative factors over safe operation. Therefore, the operator bears the responsibility of making a judgement and decreasing the load and lowering speed.
- 5.All ratings are calculated when the machine is parking on firm and level ground with less than 1% gradient.

Load chart -H (Main hook, Boom 16~82m, without extension jib) 1/2

Boom length/ radius (m)	16	19	22	25	28	31	34	37	40	43	46	49	Boom length/ radius (m)
5	180.0	171.0											5
6	166.0	158.8	149.1	138.9									6
7	150.0	145.9	141.9	136.1	132.7	123.9	114.4						7
8	132.0	130.9	130.0	128.8	127.9	122.8	115.2	106.6	98.8	92.2			8
9	114.0	114.0	114.0	111.0	110.1	108.1	105.7	103.3	97.8	91.1	81.0	80.6	9
10	97.0	96.9	96.8	96.7	95.3	94.6	93.3	91.3	89.4	87.2	80.2	78.6	10
12	74.5	74.5	74.5	74.5	74.5	74.5	73.1	72.4	72.3	71.1	69.9	68.6	12
14	59.9	59.9	59.9	59.9	59.9	59.9	59.9	59.9	59.8	58.6	58.1	58.0	14
16	50.2	50.0	50.0	50.0	50.0	50.0	50.0	50.0	49.9	49.2	48.4	48.2	16
18		42.1	42.4	42.2	42.1	41.9	41.8	41.7	42.5	42.3	42.3	41.4	18
20			37.1	37.1	37.1	37.0	37.0	37.0	36.8	36.7	36.6	36.5	20
22				32.6	32.6	32.5	32.5	32.5	32.3	32.2	32.1	32.0	22
24				30.0	29.0	28.9	28.9	28.8	28.7	28.5	28.5	28.3	24
26					26.1	25.9	25.9	25.8	25.7	25.5	25.5	25.3	26
28						23.5	23.5	23.3	23.2	23.0	23.0	22.8	28
30							21.4	21.2	21.0	20.8	20.8	20.6	30
32								19.4	19.3	19.1	19.0	18.8	32
34								17.3	17.7	17.5	17.4	17.2	34
36									16.4	16.2	16.1	15.8	36
38										15.0	14.8	14.6	38
40											13.8	13.6	40
42												12.6	42
44												11.7	44
46													46
48													48
50													50
52													52
54													54
56													56
58													58
60													60
62													62
64													64
66													66
68													68
70													70
72													72
Counter weight(t)	68+25	68+25	68+25	68+25	68+25	68+25	68+25	68+25	68+25	68+25	68+25	68+25	Counter weight(t)
Parts of line	16	14	12	11	10	10	9	8	8	7	6	6	Parts of line

H Load Chart

Load chart -H (Main hook, Boom 16~82m, without extension jib) 2/2

Boom length/ radius (m)	52	55	58	61	64	67	70	73	76	79	82	Boom length/ radius (m)
5												5
6												6
7												7
8												8
9	74.9											9
10	73.1	67.4	64.2	61.1								10
12	67.4	63.3	62.3	58.7	53.9	50.7	46.5	42.5	39.2	36.1		12
14	56.7	55.7	54.8	53.9	51.1	49.6	45.1	41.3	38.6	35.9	32.8	14
16	48.0	47.9	47.1	46.3	45.6	44.8	42.6	40.1	37.1	35.0	31.9	16
18	40.9	40.7	40.6	40.4	39.8	39.1	38.5	37.5	35.5	33.9	30.9	18
20	36.0	35.3	35.1	35.0	34.8	34.5	34.0	33.4	32.8	32.1	29.9	20
22	31.8	31.5	31.0	30.6	30.5	30.3	30.1	29.7	29.2	28.7	28.1	22
24	28.2	28.0	27.9	27.3	27.0	26.8	26.6	26.4	26.2	25.7	25.1	24
26	25.1	24.9	24.9	24.7	24.2	23.9	23.8	23.6	23.4	23.1	22.6	26
28	22.6	22.4	22.3	22.1	21.9	21.5	21.3	21.1	20.9	20.7	20.4	28
30	20.4	20.2	20.2	20.0	19.8	19.5	19.3	19.0	18.9	18.7	18.4	30
32	18.6	18.4	18.3	18.1	17.9	17.7	17.5	17.3	17.1	16.9	16.6	32
34	17.0	16.8	16.7	16.5	16.3	16.1	15.9	15.7	15.5	15.3	15.1	34
36	15.7	15.4	15.3	15.1	14.9	14.7	14.5	14.3	14.1	13.9	13.7	36
38	14.5	14.2	14.1	13.9	13.7	13.5	13.3	13.1	12.9	12.7	12.5	38
40	13.4	13.2	13.0	12.8	12.6	12.4	12.3	12.0	11.8	11.6	11.4	40
42	12.4	12.2	12.1	11.8	11.7	11.4	11.3	11.1	10.9	10.7	10.4	42
44	11.5	11.3	11.2	11.0	10.8	10.6	10.4	10.2	10.0	9.8	9.6	44
46	10.7	10.5	10.4	10.2	10.0	9.8	9.6	9.4	9.2	9.0	8.8	46
48		9.8	9.7	9.4	9.3	9.0	8.9	8.7	8.5	8.3	8.0	48
50			9.0	8.8	8.6	8.4	8.2	8.0	7.8	7.6	7.4	50
52			8.4	8.2	8.0	7.8	7.6	7.4	7.2	7.0	6.7	52
54				7.6	7.4	7.2	7.1	6.8	6.6	6.4	6.2	54
56					6.9	6.7	6.5	6.3	6.1	5.9	5.7	56
58						6.2	6.0	5.8	5.6	5.4	5.2	58
60						5.7	5.6	5.4	5.2	4.9	4.7	60
62							5.2	4.9	4.8	4.5	4.2	62
64								4.6	4.4	4.1	3.8	64
66									4.0	3.7	3.4	66
68										3.4	3.0	68
70										3.0	2.6	70
72											2.3	72
Counter weight(t)	68+25	68+25	68+25	68+25	68+25	68+25	68+25	68+25	68+25	68+25	68+25	Counter weight(t)
Parts of line	6	5	5	5	4	4	4	4	3	3	3	Parts of line

FJ Configuration

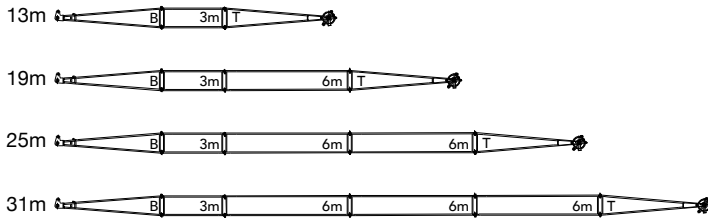

	Fixed jib base
	3m jib top
	6m jib insert
	Fixed jib top

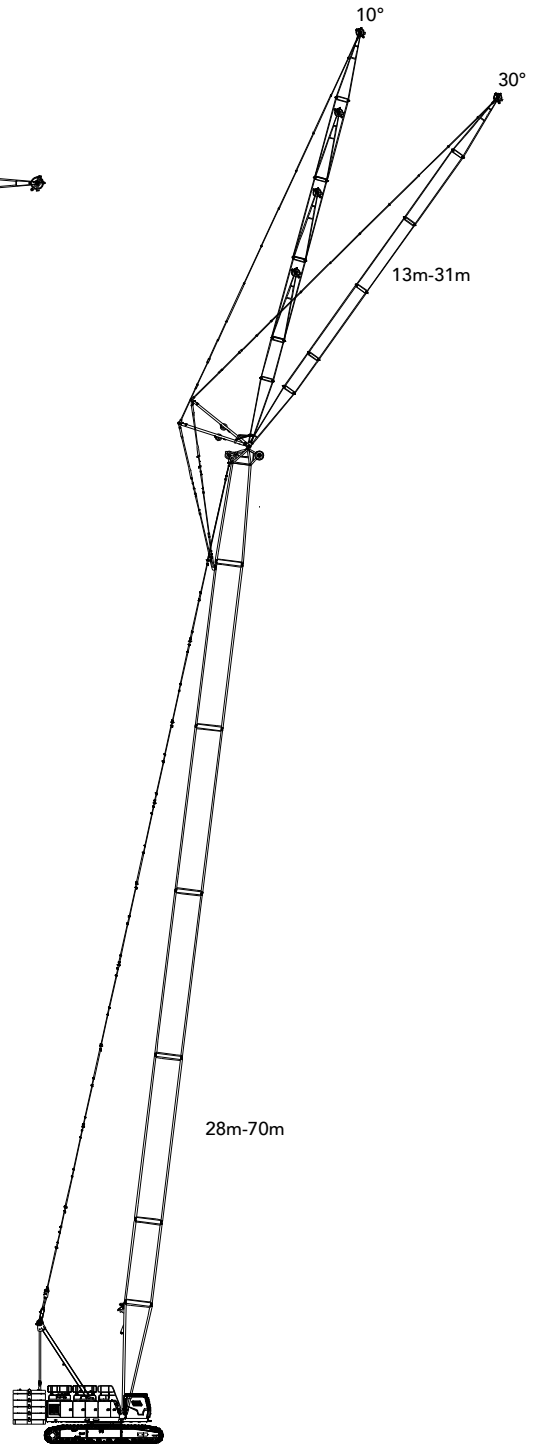

FJ Working Radius

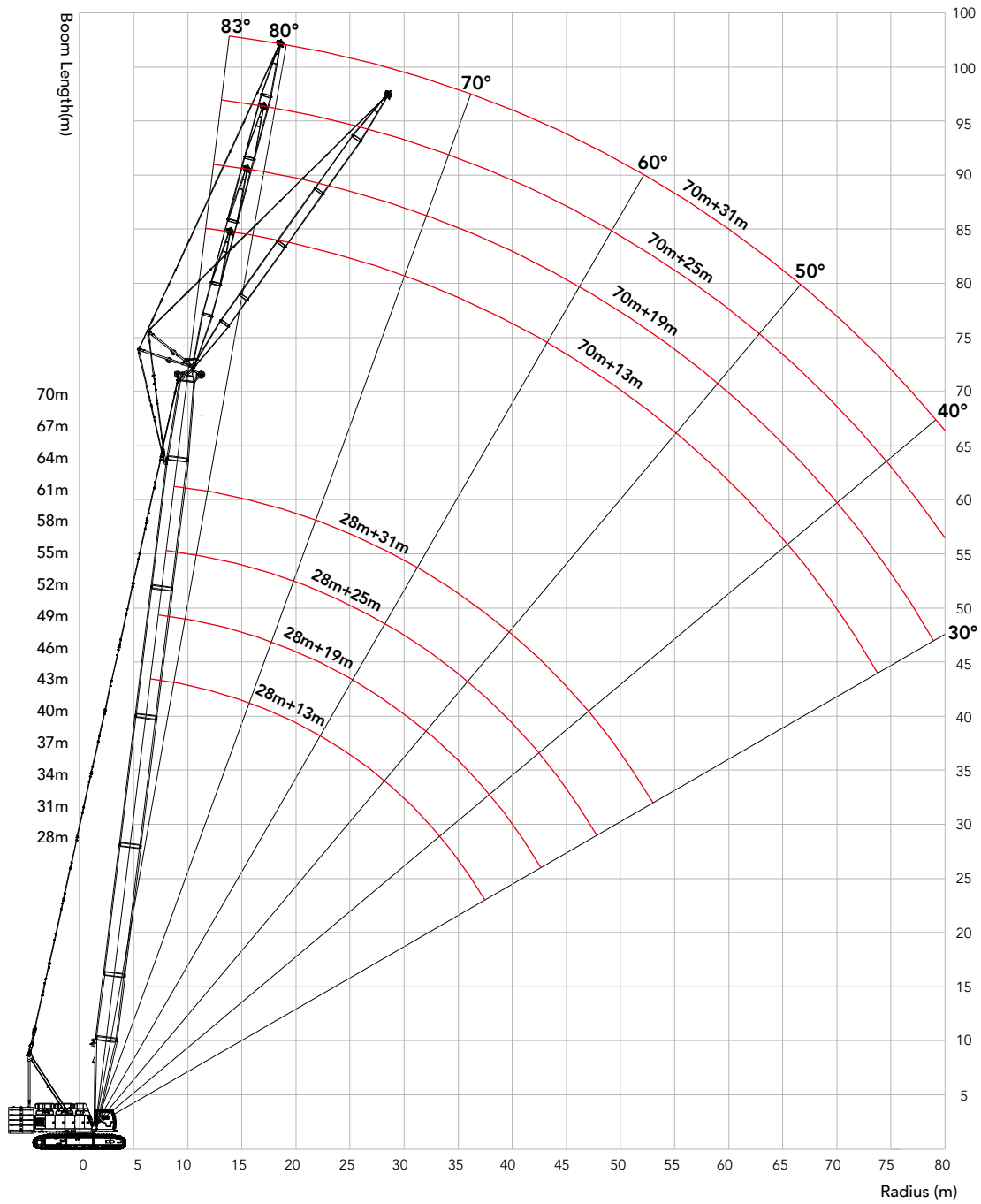

FJ Load Chart

Note:

- 1.The rated load in the load chart is calculated complying with EN 13000;
- 2.The working radius is the horizontal distance from the load center to the slewing center;
- 3.The actual lifting capacity must subtract the weight of hooks and other riggings from the rated capacity in the load chart.
- 4.The load value is calculated when the object is hung freely,without considering the influence of wind on the load, ground conditions and slope, operation speed and the influence of any other negative factors over safe operation. Therefore, the operator bears the responsibility of making a judgement and decreasing the load and lowering speed.
- 5.All ratings are calculated when the machine is parking on firm and level ground with less than 1% gradient.

Load chart -FJa (Aux. hook, Boom 28~70m) 1/8

Load chart -FJa (Aux. hook, Boom 28~70m) 1/8																
Jib 13m, Boom to jib angle 10°																
Boom length (m) \ Radius (m)	28	31	34	37	40	43	46	49	52	55	58	61	64	67	70	Boom length (m) \ Radius (m)
10	34.0	33.4														10
12	32.3	32.3	32.1	31.9												12
14	31.6	31.5	31.5	31.5	31.6	31.3										14
16	30.7	30.9	31.0	30.9	30.5	30.2	29.9	29.7	29.5	29.2						16
18	30.0	30.1	30.3	30.0	29.6	29.3	29.0	28.8	28.6	28.3	28.1	27.9	27.7	27.5		18
20	29.3	29.5	29.6	29.2	28.8	28.5	28.2	27.9	27.6	27.5	27.3	27.0	26.4	25.9	25.3	20
22	28.8	28.9	28.2	27.9	27.7	27.4	27.1	26.8	26.5	26.3	26.1	25.6	25.0	24.5	23.8	22
24	28.0	27.3	26.7	26.4	26.1	25.8	25.6	25.3	25.1	24.9	24.6	24.3	23.6	23.0	22.3	24
26	26.2	25.8	25.3	25.0	24.7	24.5	24.3	24.1	23.9	23.6	23.1	22.6	22.0	21.5	20.8	26
28	24.3	24.1	24.0	23.8	23.6	23.4	23.2	23.1	22.4	21.9	21.6	21.1	20.5	20.0	19.3	28
30	22.3	22.1	21.9	21.7	21.6	21.4	21.2	21.0	20.9	20.2	20.0	19.8	19.3	18.7	18.0	30
32	20.5	20.3	20.2	19.9	19.8	19.6	19.4	19.2	19.1	18.9	18.7	18.5	18.0	17.5	16.9	32
34	18.9	18.7	18.6	18.4	18.2	18.0	17.9	17.7	17.5	17.3	17.1	16.9	16.8	16.2	15.6	34
36	17.6	17.4	17.2	17.0	16.9	16.6	16.5	16.3	16.1	15.9	15.8	15.6	15.4	15.0	14.5	36
38	16.4	16.2	16.0	15.8	15.6	15.4	15.3	15.1	14.9	14.7	14.5	14.3	14.2	14.0	13.6	38
40		15.1	15.0	14.7	14.6	14.3	14.2	14.0	13.8	13.6	13.5	13.3	13.1	12.9	12.7	40
42			14.0	13.8	13.6	13.4	13.2	13.0	12.8	12.6	12.5	12.3	12.1	11.9	11.7	42
44				12.9	12.7	12.5	12.4	12.1	12.0	11.7	11.6	11.4	11.2	11.0	10.8	44
46				12.1	11.9	11.7	11.6	11.3	11.2	10.9	10.8	10.6	10.4	10.2	10.0	46
48					11.2	11.0	10.8	10.6	10.4	10.2	10.1	9.9	9.7	9.5	9.3	48
50						10.3	10.2	9.9	9.8	9.5	9.4	9.2	9.0	8.8	8.6	50
52							9.5	9.3	9.1	8.9	8.8	8.6	8.4	8.1	7.9	52
54							9.0	8.8	8.6	8.4	8.2	8.0	7.8	7.5	7.3	54
56								8.2	8.1	7.8	7.7	7.4	7.2	6.9	6.8	56
58									7.6	7.3	7.1	6.9	6.7	6.4	6.2	58
60										6.8	6.7	6.4	6.2	5.9	5.7	60
62										6.4	6.2	6.0	5.7	5.5	5.3	62
64											5.8	5.5	5.3	5.1	4.9	64
66												5.1	4.9	4.7	4.5	66
68													4.5	4.3	4.1	68
70														3.9	3.7	70
72															3.6	72
74																74
Counter weight(t)	68+25	68+25	68+25	68+25	68+25	68+25	68+25	68+25	68+25	68+25	68+25	68+25	68+25	68+25	68+25	Counter weight(t)
Parts of line	3	3	3	3	3	3	3	3	3	3	3	3	3	3	2	Parts of line

FJ Load Chart

Load chart -FJa (Aux. hook, Boom 28~70m) 2/8

Load chart -FJa (Aux. hook, Boom 28~70m) 2/8																
Jib 19m, Boom to jib angle 10°																
Boom length (m) Radius (m)	28	31	34	37	40	43	46	49	52	55	58	61	64	67	70	Boom length (m) Radius (m)
14	21.5	21.6														14
16	20.9	21.0	21.0	21.1	21.1	21.1										16
18	20.2	20.4	20.5	20.6	20.5	20.6	20.6	20.5	20.4	20.4						18
20	19.6	19.7	20.0	20.0	20.1	20.2	20.2	20.2	20.1	20.0	19.9	19.8	19.7	19.5		20
22	19.0	19.2	19.4	19.6	19.7	19.6	19.7	19.7	19.7	19.7	19.6	19.5	19.4	19.2	19.1	22
24	18.5	18.7	18.9	19.1	19.1	19.3	19.3	19.4	19.4	19.3	19.3	19.2	19.2	19.0	18.8	24
26	18.0	18.3	18.5	18.6	18.7	18.9	18.9	19.1	19.0	19.0	19.0	18.9	18.8	18.7	18.6	26
28	17.6	17.9	18.0	18.2	18.3	18.5	18.6	18.6	18.7	18.6	18.6	18.6	18.5	18.5	18.3	28
30	17.2	17.4	17.7	17.8	18.0	18.1	18.2	18.3	18.3	18.3	18.4	18.3	18.3	18.2	18.0	30
32	16.4	16.5	16.7	16.8	16.9	17.0	17.1	17.2	17.3	17.4	17.5	17.6	17.7	17.5	17.2	32
34	15.6	15.7	15.9	16.0	16.1	16.2	16.3	16.4	16.5	16.6	16.7	16.8	16.7	16.3	15.9	34
36	14.9	15.0	15.2	15.3	15.4	15.5	15.6	15.7	15.8	15.9	16.0	15.9	15.6	15.2	14.8	36
38	14.1	14.2	14.4	14.5	14.6	14.7	14.8	14.9	15.0	15.0	14.8	14.6	14.5	14.1	13.8	38
40	13.6	13.7	13.8	13.9	14.0	14.1	14.2	14.3	14.1	13.9	13.7	13.5	13.4	13.2	12.9	40
42	12.9	13.0	13.1	13.2	13.3	13.4	13.5	13.3	13.1	12.9	12.8	12.6	12.4	12.2	12.0	42
44	12.2	12.3	12.5	12.6	12.7	12.7	12.6	12.4	12.2	12.0	11.9	11.7	11.5	11.3	11.1	44
46		11.8	12.0	12.1	12.2	11.9	11.8	11.6	11.4	11.2	11.1	10.9	10.7	10.5	10.3	46
48			11.5	11.6	11.4	11.2	11.1	10.9	10.7	10.5	10.3	10.1	9.9	9.7	9.6	48
50				10.9	10.8	10.5	10.4	10.2	10.0	9.8	9.7	9.5	9.3	9.1	8.9	50
52				10.3	10.1	9.9	9.8	9.6	9.4	9.2	9.0	8.8	8.6	8.4	8.3	52
54					9.6	9.4	9.2	9.0	8.8	8.6	8.5	8.3	8.1	7.8	7.6	54
56						8.8	8.7	8.5	8.3	8.1	7.9	7.7	7.5	7.3	7.1	56
58							8.2	8.0	7.8	7.6	7.4	7.2	7.0	6.7	6.5	58
60								7.5	7.4	7.1	7.0	6.7	6.5	6.2	6.1	60
62								7.1	6.9	6.7	6.5	6.2	6.0	5.8	5.6	62
64									6.5	6.2	6.1	5.8	5.6	5.4	5.2	64
66										5.8	5.7	5.4	5.2	5.0	4.8	66
68											5.3	5.0	4.8	4.6	4.4	68
70											4.9	4.7	4.5	4.2	4.0	70
72												4.3	4.1	3.9	3.7	72
74													3.8	3.6	3.4	74
76														3.3	3.1	76
78														3.0	2.8	78
80															2.5	80
Counter weight(t)	68+25	68+25	68+25	68+25	68+25	68+25	68+25	68+25	68+25	68+25	68+25	68+25	68+25	68+25	68+25	Counter weight(t)
Parts of line	2	2	2	2	2	2	2	2	2	2	2	2	2	2	2	Parts of line

FJ Load Chart

Load chart -FJa (Aux. hook, Boom 28~70m) 3/8																
Jib 25m, Boom to jib angle 10°																
Boom length (m) Radius (m)	28	31	34	37	40	43	46	49	52	55	58	61	64	67	70	Boom length (m) Radius (m)
16	15.8	15.8														16
18	15.3	15.4	15.4	15.4	15.3	15.3										18
20	14.9	14.9	14.9	15.0	14.9	14.9	14.9	14.8	14.8	14.7						20
22	14.4	14.5	14.5	14.5	14.5	14.5	14.5	14.5	14.4	14.4	14.3	14.1	14.0	13.8		22
24	14.0	14.0	14.1	14.1	14.2	14.2	14.2	14.2	14.1	14.1	14.0	13.9	13.8	13.6	13.4	24
26	13.5	13.6	13.7	13.8	13.8	13.8	13.8	13.8	13.8	13.8	13.7	13.6	13.5	13.4	13.2	26
28	13.1	13.2	13.3	13.4	13.4	13.5	13.5	13.5	13.5	13.5	13.4	13.3	13.3	13.1	12.9	28
30	12.8	12.8	12.9	13.0	13.1	13.1	13.1	13.2	13.2	13.2	13.1	13.1	13.0	12.9	12.7	30
32	12.4	12.5	12.6	12.7	12.7	12.7	12.7	12.8	12.9	12.9	12.8	12.8	12.7	12.6	12.5	32
34	12.1	12.2	12.2	12.3	12.3	12.3	12.4	12.5	12.6	12.6	12.5	12.6	12.5	12.3	12.2	34
36	11.6	11.7	11.8	11.9	11.9	12.0	12.0	12.1	12.2	12.3	12.3	12.3	12.2	12.0	11.9	36
38	11.2	11.3	11.4	11.5	11.6	11.5	11.6	11.7	11.8	11.9	11.9	11.8	11.7	11.6	11.5	38
40	10.7	10.8	10.9	11.0	11.1	11.1	11.2	11.3	11.4	11.5	11.6	11.5	11.4	11.3	11.2	40
42	10.2	10.3	10.4	10.5	10.6	10.7	10.8	10.9	11.0	11.1	11.2	11.1	11.0	10.9	10.8	42
44	9.8	9.9	10.0	10.1	10.2	10.3	10.4	10.5	10.6	10.7	10.8	10.7	10.6	10.5	10.4	44
46	9.4	9.5	9.6	9.7	9.8	9.9	10.0	10.1	10.2	10.3	10.4	10.3	10.2	10.1	10.0	46
48	9.0	9.1	9.2	9.3	9.4	9.5	9.6	9.7	9.8	9.9	10.0	9.9	9.8	9.7	9.6	48
50		8.8	8.9	9.0	9.1	9.2	9.3	9.4	9.5	9.5	9.6	9.5	9.4	9.3	9.1	50
52		8.5	8.6	8.7	8.8	8.9	9.0	9.1	9.2	9.2	9.2	9.0	8.9	8.7	8.5	52
54			8.2	8.3	8.4	8.5	8.6	8.7	8.8	8.8	8.7	8.5	8.3	8.1	7.9	54
56				8.0	8.1	8.2	8.3	8.4	8.5	8.3	8.1	7.9	7.8	7.5	7.3	56
58					7.8	7.9	8.0	8.1	8.0	7.8	7.6	7.4	7.2	7.0	6.8	58
60					7.5	7.6	7.7	7.8	7.5	7.3	7.2	7.0	6.7	6.5	6.3	60
62						7.2	7.3	7.4	7.1	6.9	6.7	6.5	6.3	6.0	5.9	62
64							7.0	7.1	6.7	6.5	6.3	6.1	5.9	5.6	5.4	64
66								6.5	6.3	6.1	5.9	5.7	5.4	5.2	5.0	66
68									6.1	5.9	5.7	5.5	5.3	5.1	4.8	68
70										5.6	5.3	5.2	4.9	4.7	4.5	70
72											5.0	4.8	4.6	4.4	4.1	72
74												4.5	4.3	4.1	3.8	74
76													4.0	3.8	3.5	76
78														3.7	3.5	78
80															3.2	80
82																82
84																84
Counter weight(t)	68+25	68+25	68+25	68+25	68+25	68+25	68+25	68+25	68+25	68+25	68+25	68+25	68+25	68+25	68+25	Counter weight(t)
Parts of line	2	2	2	2	2	2	2	2	2	2	2	2	2	2	1	Parts of line

FJ Load Chart

Load chart -FJa (Aux. hook, Boom 28~70m) 4/8

Load chart -FJa (Aux. hook, Boom 28~70m) 4/8																
Jib 31m, Boom to jib angle 10°																
Boom length (m) Radius (m)	28	31	34	37	40	43	46	49	52	55	58	61	64	67	70	Boom length (m) Radius (m)
18	9.8	9.8														18
20	9.5	9.5	9.5	9.6	9.6	9.6										20
22	9.2	9.2	9.2	9.3	9.3	9.3	9.3	9.3	9.3	9.3						22
24	8.9	8.9	9.0	9.0	9.1	9.1	9.1	9.1	9.1	9.1	9.1	9.0	9.0	8.9		24
26	8.6	8.7	8.7	8.8	8.8	8.8	8.9	8.9	8.9	8.9	8.9	8.9	8.8	8.8	8.8	26
28	8.4	8.4	8.5	8.5	8.6	8.6	8.6	8.7	8.7	8.7	8.7	8.7	8.6	8.6	8.5	28
30	8.1	8.2	8.2	8.3	8.3	8.4	8.4	8.5	8.5	8.5	8.5	8.5	8.5	8.5	8.4	30
32	7.8	8.0	8.0	8.1	8.1	8.2	8.2	8.2	8.3	8.3	8.3	8.3	8.3	8.3	8.2	32
34	7.6	7.7	7.7	7.8	7.9	8.0	8.0	8.1	8.1	8.1	8.1	8.1	8.1	8.1	8.1	34
36	7.3	7.5	7.5	7.6	7.7	7.7	7.8	7.9	7.9	7.9	7.9	8.0	7.9	7.9	7.9	36
38	7.0	7.2	7.3	7.3	7.4	7.4	7.5	7.7	7.7	7.7	7.8	7.8	7.8	7.8	7.8	38
40	6.8	7.0	7.1	7.1	7.2	7.3	7.4	7.5	7.5	7.6	7.6	7.6	7.6	7.6	7.6	40
42	6.6	6.7	6.8	6.9	7.0	7.1	7.2	7.3	7.4	7.4	7.4	7.5	7.5	7.5	7.5	42
44	6.3	6.5	6.6	6.7	6.8	6.9	7.0	7.1	7.2	7.3	7.3	7.3	7.3	7.3	7.3	44
46	6.2	6.3	6.4	6.5	6.6	6.7	6.8	6.9	7.0	7.1	7.1	7.2	7.2	7.2	7.1	46
48	6.0	6.1	6.2	6.3	6.4	6.5	6.6	6.7	6.8	6.9	7.0	7.0	7.1	7.1	7.0	48
50	5.8	5.9	6.0	6.1	6.2	6.3	6.4	6.5	6.6	6.7	6.8	6.9	6.9	6.9	6.8	50
52	5.6	5.7	5.8	5.9	6.0	6.1	6.2	6.3	6.4	6.5	6.6	6.7	6.8	6.8	6.7	52
54	5.4	5.5	5.6	5.7	5.8	5.9	6.0	6.1	6.2	6.3	6.4	6.5	6.6	6.7	6.5	54
56		5.3	5.4	5.5	5.6	5.7	5.8	5.9	6.0	6.1	6.2	6.3	6.4	6.5	6.3	56
58		5.1	5.2	5.3	5.4	5.5	5.6	5.7	5.8	5.9	6.0	6.1	6.2	6.3	6.1	58
60			4.9	5.0	5.1	5.2	5.3	5.4	5.5	5.6	5.7	5.8	5.9	6.0	5.9	60
62				4.7	4.8	4.9	5.0	5.1	5.2	5.3	5.4	5.5	5.6	5.7	5.6	62
64					4.5	4.6	4.7	4.8	4.9	5.0	5.1	5.2	5.3	5.4	5.3	64
66						4.3	4.4	4.5	4.6	4.7	4.8	4.9	5.0	5.1	5.0	66
68						4.0	4.1	4.2	4.3	4.4	4.5	4.6	4.7	4.8	4.7	68
70							3.8	3.9	4.0	4.1	4.2	4.3	4.4	4.5	4.4	70
72								3.6	3.7	3.8	3.9	4.0	4.1	4.2	4.1	72
74									3.4	3.5	3.6	3.7	3.8	3.9	3.8	74
76									3.1	3.2	3.3	3.4	3.5	3.6	3.5	76
78										2.9	3.0	3.1	3.2	3.3	3.2	78
80											2.7	2.8	2.9	3.0	3.0	80
82												2.5	2.6	2.7	2.7	82
84													2.2	2.3	2.4	84
86															2.2	86
Counter weight(t)	68+25	68+25	68+25	68+25	68+25	68+25	68+25	68+25	68+25	68+25	68+25	68+25	68+25	68+25	68+25	Counter weight(t)
Parts of line	1	1	1	1	1	1	1	1	1	1	1	1	1	1	1	Parts of line

FJ Load Chart

Load chart -FJa (Aux. hook, Boom 28~70m) 5/8																
Jib 13m, Boom to jib angle 30°																
Boom length Radius (m)	28	31	34	37	40	43	46	49	52	55	58	61	64	67	70	Boom length Radius (m)
16	17.6	17.8														16
18	17.0	17.1	17.4	17.5	17.6	17.7										18
20	16.4	16.6	16.8	17.0	17.1	17.2	17.3	17.4	17.4	17.6						20
22	15.7	15.9	16.3	16.4	16.7	16.8	16.9	17.0	17.0	17.1	17.1	17.3	17.3	17.3		22
24	15.1	15.3	15.8	16.0	16.1	16.3	16.4	16.5	16.7	16.8	16.8	16.9	16.9	16.9	17.0	24
26	14.7	14.9	15.1	15.4	15.7	15.9	16.1	16.2	16.3	16.4	16.4	16.5	16.7	16.7	16.7	26
28	14.2	14.4	14.6	14.8	15.0	15.5	15.7	15.8	15.9	16.1	16.2	16.3	16.3	16.4	16.4	28
30	13.8	14.0	14.2	14.4	14.6	15.1	15.3	15.5	15.7	15.8	15.9	16.0	16.0	16.1	16.1	30
32	13.5	13.7	13.9	14.1	14.3	14.7	14.9	15.2	15.3	15.5	15.6	15.7	15.7	15.8	15.8	32
34	13.2	13.4	13.6	13.8	14.0	14.2	14.4	14.6	14.8	15.1	15.3	15.5	15.4	15.5	15.4	34
36	12.8	13.0	13.2	13.4	13.6	13.8	14.0	14.2	14.4	14.6	14.9	15.2	15.0	15.0	14.8	36
38	12.5	12.7	12.9	13.1	13.3	13.5	13.7	13.9	14.1	14.3	14.5	14.8	14.4	14.3	14.1	38
40		12.4	12.6	12.8	13.0	13.2	13.4	13.6	13.8	13.9	13.9	13.7	13.5	13.4	13.2	40
42		12.1	12.3	12.5	12.7	12.9	13.1	13.3	13.2	13.0	12.9	12.7	12.5	12.3	12.2	42
44			12.0	12.2	12.4	12.6	12.5	12.4	12.3	12.1	11.9	11.8	11.6	11.4	11.3	44
46				11.9	12.0	11.9	11.8	11.6	11.4	11.2	11.1	10.9	10.8	10.6	10.4	46
48					11.3	11.1	11.0	10.8	10.7	10.5	10.4	10.2	10.0	9.8	9.7	48
50						10.4	10.3	10.1	10.0	9.8	9.7	9.5	9.3	9.1	9.0	50
52						9.7	9.7	9.5	9.3	9.1	9.0	8.8	8.7	8.5	8.3	52
54							9.1	8.9	8.7	8.5	8.4	8.2	8.1	7.8	7.7	54
56								8.3	8.2	8.0	7.9	7.7	7.5	7.2	7.1	56
58									7.7	7.5	7.3	7.1	6.9	6.7	6.5	58
60									7.2	6.9	6.8	6.6	6.4	6.2	6.0	60
62										6.5	6.3	6.1	5.9	5.7	5.5	62
64											5.9	5.7	5.5	5.2	5.1	64
66												5.2	5.0	4.8	4.7	66
68												4.8	4.6	4.4	4.3	68
70													4.3	4.0	3.9	70
72														3.7	3.5	72
74															3.2	74
Counter weight(t) Parts of line	68+25	68+25	68+25	68+25	68+25	68+25	68+25	68+25	68+25	68+25	68+25	68+25	68+25	68+25	68+25	Counter weight(t) Parts of line
	2	2	2	2	2	2	2	2	2	2	2	2	2	2	2	

FJ Load Chart

Load chart -FJa (Aux. hook, Boom 28~70m) 6/8

Load chart -FJa (Aux. hook, Boom 28~70m) 6/8																
Jib 19m, Boom to jib angle 30°																
Boom length (m) Radius (m)	28	31	34	37	40	43	46	49	52	55	58	61	64	67	70	Boom length (m) Radius (m)
20	12.1	12.3														20
22	11.7	11.8	12.0	12.1	12.2	12.2										22
24	11.3	11.4	11.6	11.7	11.8	11.9	12.0	12.0	12.1	12.1						24
26	10.8	11.1	11.2	11.3	11.5	11.5	11.7	11.7	11.8	11.8	11.9	11.9	12.0	12.1		26
28	10.4	10.7	10.8	11.0	11.1	11.2	11.4	11.4	11.6	11.6	11.7	11.7	11.8	11.8	11.8	28
30	10.0	10.3	10.4	10.7	10.8	10.9	11.1	11.2	11.3	11.3	11.4	11.5	11.6	11.6	11.6	30
32	9.6	9.8	10.0	10.4	10.6	10.7	10.8	10.9	11.0	11.1	11.2	11.2	11.3	11.4	11.4	32
34	9.4	9.5	9.6	10.1	10.3	10.4	10.6	10.7	10.7	10.9	10.9	11.0	11.1	11.2	11.2	34
36	9.1	9.2	9.3	9.7	10.0	10.2	10.4	10.5	10.5	10.7	10.7	10.9	10.9	11.0	11.0	36
38	8.9	9.0	9.1	9.4	9.7	10.0	10.1	10.3	10.4	10.4	10.6	10.7	10.7	10.8	10.9	38
40	8.6	8.7	8.8	9.2	9.4	9.7	9.9	10.0	10.2	10.2	10.4	10.4	10.6	10.6	10.6	40
42	8.3	8.4	8.5	8.8	9.2	9.5	9.7	9.9	10.0	10.1	10.2	10.3	10.3	10.4	10.3	42
44	8.2	8.3	8.4	8.7	9.0	9.3	9.6	9.7	9.9	9.9	10.0	10.1	10.2	10.2	10.1	44
46		8.2	8.3	8.6	8.9	9.1	9.4	9.6	9.7	9.8	9.9	9.9	9.9	10.0	9.9	46
48		8.1	8.2	8.5	8.8	9.0	9.2	9.4	9.5	9.6	9.8	9.8	9.8	9.8	9.7	48
50			8.1	8.4	8.7	8.9	9.0	9.1	9.4	9.4	9.5	9.6	9.6	9.5	9.4	50
52				8.3	8.6	8.8	8.8	9.0	9.2	9.2	9.2	9.2	9.1	8.9	8.8	52
54					8.5	8.7	8.7	8.9	8.9	8.9	8.8	8.6	8.5	8.3	8.2	54
56						8.6	8.5	8.7	8.5	8.4	8.3	8.1	7.9	7.7	7.6	56
58						8.4	8.3	8.2	8.0	7.9	7.7	7.6	7.4	7.2	7.0	58
60							7.8	7.7	7.5	7.4	7.2	7.0	6.9	6.7	6.5	60
62								7.2	7.1	6.9	6.8	6.6	6.4	6.2	6.0	62
64									6.6	6.4	6.3	6.1	5.9	5.7	5.5	64
66									6.2	6.0	5.9	5.7	5.5	5.3	5.1	66
68										5.6	5.5	5.2	5.1	4.9	4.7	68
70											5.1	4.9	4.7	4.5	4.3	70
72												4.5	4.3	4.1	4.0	72
74												4.1	4.0	3.8	3.6	74
76													3.6	3.4	3.3	76
78														3.1	3.0	78
80															2.6	80
Counter weight(t) Parts of line	68+25 1	68+25 1	68+25 1	68+25 1	68+25 1	68+25 1	68+25 1	68+25 1	68+25 1	68+25 1	68+25 1	68+25 1	68+25 1	68+25 1	74+25 1	Counter weight(t) Parts of line

FJ Load Chart

Load chart -FJa (Aux. hook, Boom 28~70m) 7/8																
Jib 25m, Boom to jib angle 30°																
Boom length (m) Radius (m)	28	31	34	37	40	43	46	49	52	55	58	61	64	67	70	Boom length (m) Radius (m)
24	8.6	8.7														24
26	8.3	8.4	8.5	8.6	8.6	8.7										26
28	8.0	8.1	8.2	8.3	8.3	8.4	8.5	8.5	8.6	8.6						28
30	7.7	7.8	7.9	8.0	8.1	8.2	8.2	8.3	8.4	8.4	8.4	8.4	8.5	8.5		30
32	7.4	7.5	7.6	7.8	7.9	7.9	8.0	8.1	8.1	8.2	8.2	8.3	8.3	8.3	8.4	32
34	7.1	7.3	7.4	7.5	7.6	7.7	7.8	7.9	7.9	8.0	8.0	8.1	8.1	8.2	8.2	34
36	7.0	7.1	7.2	7.3	7.4	7.5	7.6	7.7	7.8	7.8	7.9	7.9	8.0	8.0	8.0	36
38	6.8	6.9	7.1	7.1	7.3	7.3	7.4	7.5	7.6	7.6	7.7	7.8	7.8	7.9	7.9	38
40	6.6	6.7	6.9	7.0	7.1	7.2	7.3	7.3	7.4	7.5	7.5	7.6	7.7	7.7	7.8	40
42	6.5	6.6	6.7	6.8	6.9	7.0	7.1	7.2	7.3	7.4	7.4	7.5	7.5	7.6	7.6	42
44	6.3	6.4	6.6	6.7	6.8	6.9	7.0	7.1	7.2	7.2	7.2	7.3	7.4	7.5	7.5	44
46	6.2	6.3	6.4	6.5	6.7	6.7	6.8	6.9	7.0	7.1	7.1	7.2	7.3	7.3	7.4	46
48	6.2	6.2	6.3	6.4	6.5	6.6	6.7	6.8	6.9	6.9	7.0	7.1	7.2	7.2	7.2	48
50	6.1	6.2	6.2	6.3	6.4	6.5	6.6	6.7	6.7	6.8	6.9	7.0	7.0	7.1	7.1	50
52		6.1	6.2	6.2	6.3	6.4	6.5	6.6	6.7	6.7	6.8	6.8	6.9	7.0	7.0	52
54		6.2	6.1	6.2	6.2	6.3	6.4	6.4	6.5	6.6	6.7	6.7	6.8	6.9	6.9	54
56			6.1	6.1	6.2	6.2	6.3	6.3	6.4	6.5	6.6	6.7	6.7	6.8	6.9	56
58				6.1	6.1	6.2	6.2	6.3	6.3	6.4	6.5	6.6	6.6	6.7	6.8	58
60					6.1	6.1	6.2	6.2	6.3	6.4	6.4	6.5	6.5	6.6	6.7	60
62						6.1	6.1	6.2	6.2	6.3	6.4	6.4	6.4	6.5	6.4	62
64							6.1	6.1	6.1	6.2	6.3	6.3	6.3	6.3	6.1	64
66								6.1	6.1	6.1	6.2	6.2	6.0	5.9	5.7	66
68									6.1	5.9	6.0	5.8	5.6	5.5	5.3	68
70										5.7	5.6	5.4	5.2	5.1	4.9	70
72											5.4	5.2	5.1	4.9	4.7	72
74												4.8	4.7	4.5	4.3	74
76													4.3	4.2	4.0	76
78														3.8	3.7	78
80															3.5	80
82																82
84																84
Counter weight(t)	68+25	68+25	68+25	68+25	68+25	68+25	68+25	68+25	68+25	68+25	68+25	68+25	68+25	68+25	68+25	Counter weight(t)
Parts of line	1	1	1	1	1	1	1	1	1	1	1	1	1	1	1	Parts of line

FJ Load Chart

Load chart -FJa (Aux. hook, Boom 28~70m) 8/8

Load chart -FJa (Aux. hook, Boom 28~70m) 8/8																
Jib 31m, Boom to jib angle 30°																
Boom length (m) Radius (m)	28	31	34	37	40	43	46	49	52	55	58	61	64	67	70	Boom length (m) Radius (m)
28	6.2	6.3														28
30	6.0	6.1	6.2	6.2	6.2	6.3										30
32	5.8	5.8	5.9	6.0	6.0	6.1	6.2	6.2	6.2	6.2						32
34	5.6	5.7	5.7	5.8	5.9	5.9	5.9	6.0	6.0	6.1	6.1	6.2	6.2	6.2		34
36	5.4	5.4	5.5	5.6	5.7	5.7	5.8	5.8	5.9	5.9	6.0	6.0	6.1	6.1	6.1	36
38	5.2	5.3	5.4	5.4	5.5	5.6	5.6	5.7	5.8	5.8	5.9	5.9	5.9	6.0	6.0	38
40	5.0	5.1	5.2	5.3	5.4	5.4	5.5	5.6	5.6	5.7	5.7	5.7	5.8	5.8	5.9	40
42	4.8	5.0	5.1	5.2	5.2	5.3	5.4	5.4	5.5	5.6	5.6	5.6	5.7	5.7	5.7	42
44	4.7	4.8	4.9	5.0	5.1	5.2	5.2	5.3	5.3	5.4	5.4	5.5	5.5	5.6	5.6	44
46	4.6	4.7	4.8	4.9	4.9	5.0	5.1	5.2	5.2	5.3	5.3	5.4	5.4	5.4	5.5	46
48	4.5	4.6	4.7	4.8	4.8	4.9	5.0	5.0	5.1	5.2	5.2	5.3	5.3	5.4	5.4	48
50	4.4	4.5	4.6	4.7	4.7	4.8	4.9	4.9	5.0	5.1	5.1	5.2	5.2	5.3	5.3	50
52	4.3	4.4	4.5	4.6	4.6	4.7	4.8	4.9	4.9	5.0	5.0	5.1	5.1	5.2	5.2	52
54	4.2	4.3	4.4	4.5	4.6	4.6	4.7	4.8	4.8	4.9	4.9	5.0	5.0	5.1	5.1	54
56	4.2	4.2	4.4	4.4	4.5	4.5	4.6	4.7	4.8	4.8	4.9	4.9	5.0	5.0	5.0	56
58		4.2	4.2	4.4	4.4	4.4	4.5	4.6	4.6	4.7	4.8	4.8	4.9	4.9	4.9	58
60		4.3	4.2	4.3	4.4	4.4	4.4	4.5	4.6	4.6	4.7	4.7	4.8	4.8	4.9	60
62			4.3	4.2	4.3	4.4	4.4	4.4	4.5	4.5	4.6	4.7	4.7	4.8	4.8	62
64				4.3	4.2	4.3	4.4	4.4	4.4	4.5	4.5	4.6	4.6	4.7	4.8	64
66					4.2	4.2	4.3	4.4	4.4	4.4	4.5	4.5	4.6	4.6	4.7	66
68						4.2	4.2	4.3	4.3	4.4	4.4	4.5	4.5	4.6	4.6	68
70						4.3	4.2	4.2	4.3	4.3	4.4	4.4	4.5	4.5	4.6	70
72							4.3	4.2	4.2	4.3	4.3	4.3	4.4	4.4	4.5	72
74								4.3	4.2	4.2	4.3	4.2	4.3	4.3	4.3	74
76									4.2	4.2	4.2	4.1	4.2	4.1	4.0	76
78									4.3	4.2	4.2	4.0	4.0	3.8	3.7	78
80										4.1	4.0	3.8	3.7	3.5	3.3	80
82												3.5	3.4	3.2	3.0	82
84												3.2	3.1	2.9	2.8	84
86													2.8	2.6	2.5	86
88													2.5	2.4	2.2	88
Counter weight(t)	68+25	68+25	68+25	68+25	68+25	68+25	68+25	68+25	68+25	68+25	68+25	68+25	68+25	68+25	68+25	Counter weight(t)
Parts of line	1	1	1	1	1	1	1	1	1	1	1	1	1	1	1	Parts of line

LJ Configuration

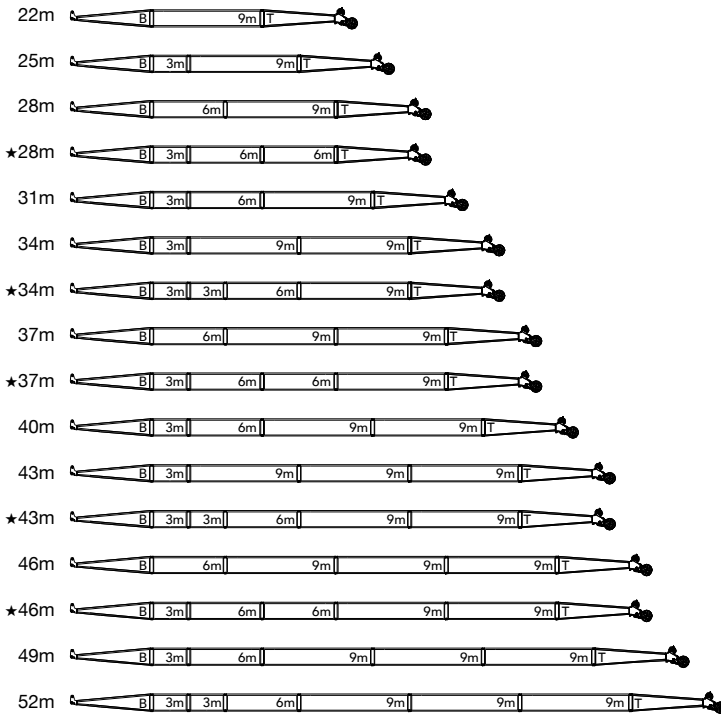

Note: ★ means recommended jib combination for purchasing.

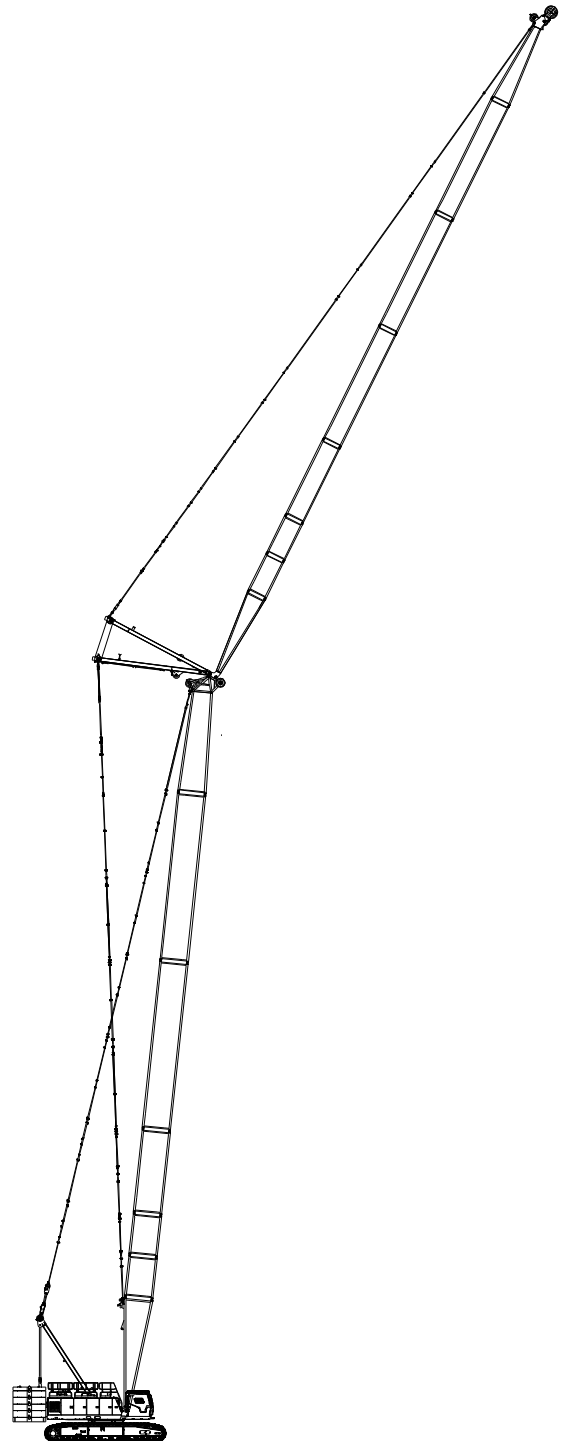
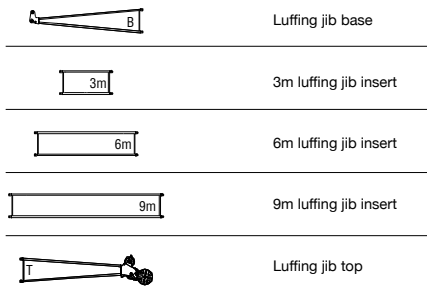

LJ Working Radius

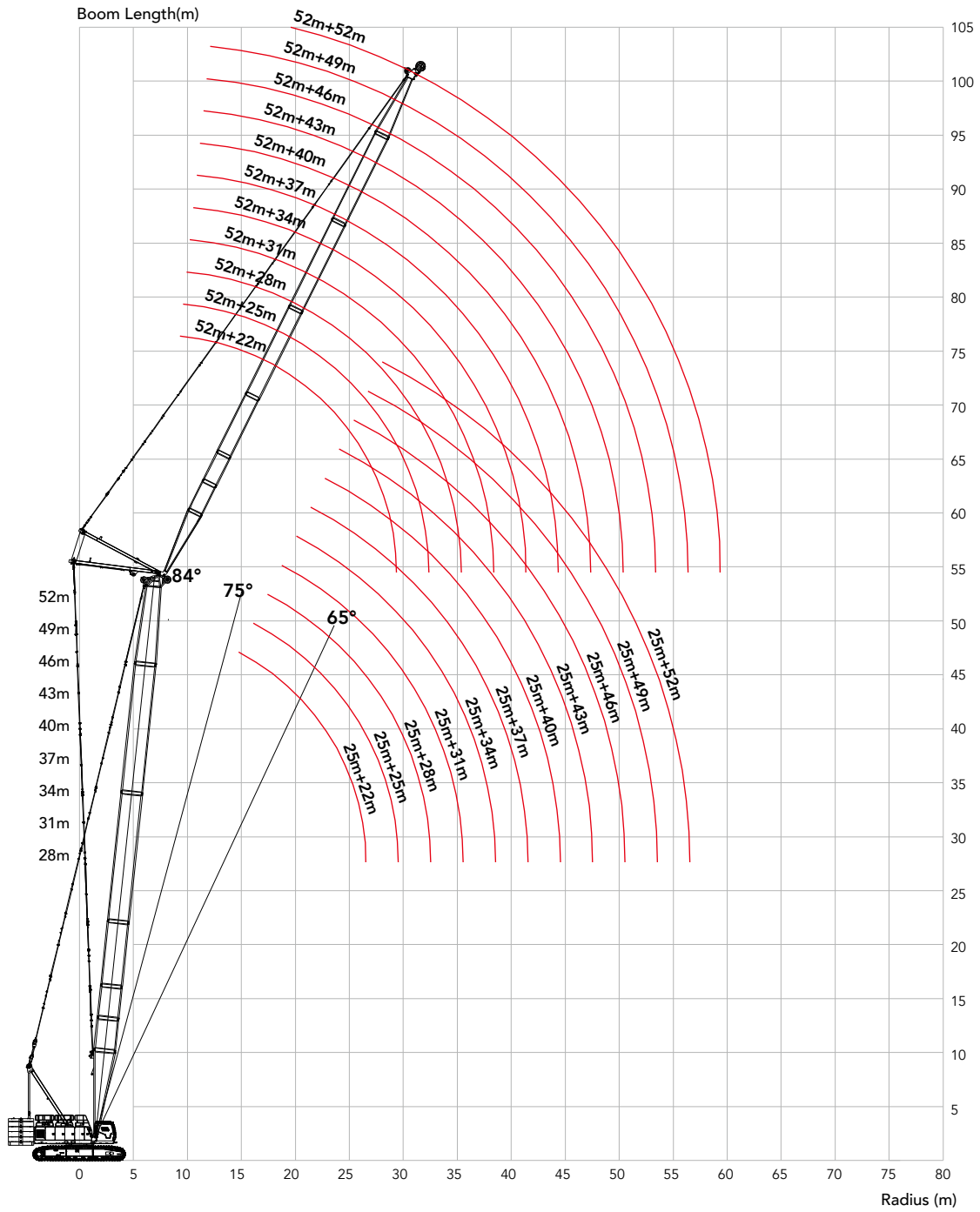

LJ Load Chart

Note:

- 1.The rated load in the load chart is calculated complying with EN 13000;
- 2.The working radius is the horizontal distance from the load center to the slewing center;
- 3.The actual lifting capacity must subtract the weight of hooks and other riggings from the rated capacity in the load chart.
- 4.The load value is calculated when the object is hung freely,without considering the influence of wind on the load, ground conditions and slope, operation speed and the influence of any other negative factors over safe operation. Therefore, the operator bears the responsibility of making a judgement and decreasing the load and lowering speed.
- 5.All ratings are calculated when the machine is parking on firm and level ground with less than 1% gradient.

Load chart -LJ (Aux. hook, Boom angle 84°) 1/10

Load chart -LJ (Aux. hook, Boom angle 84°) 1/10												
Jib length (m) Radius (m)	Boom 25m											Jib length (m) Radius (m)
	22	25	28	31	34	37	40	43	46	49	52	
12	61.3	59.6										12
14	52.7	52.2	51.0	49.9								14
16	43.1	43.4	44.5	44.4	43.6	37.7	33.0					16
18	36.4	36.6	37.6	37.4	37.3	37.2	32.7	28.5	25.0			18
20	31.4	31.6	32.5	32.3	32.2	32.1	31.9	28.2	24.7	21.7	19.2	20
22	27.6	27.7	28.5	28.4	28.3	28.1	27.9	27.8	24.3	21.4	18.8	22
24	24.5	24.7	25.4	25.2	25.1	25.0	24.8	24.7	23.9	21.0	18.4	24
26		22.2	22.8	22.7	22.6	22.4	22.3	22.1	22.0	20.7	18.1	26
28		18.3	20.7	20.6	20.5	20.3	20.2	20.0	19.9	19.7	17.7	28
30			17.9	18.8	18.7	18.5	18.4	18.2	18.1	18.0	17.4	30
32				17.2	17.1	17.0	16.8	16.7	16.6	16.4	16.3	32
34				13.3	15.8	15.7	15.5	15.4	15.3	15.1	15.0	34
36					13.0	14.5	14.4	14.3	14.1	14.0	13.8	36
38						12.6	13.4	13.3	13.1	13.0	12.8	38
40						9.9	12.1	12.4	12.2	12.1	11.9	40
42							9.9	11.5	11.4	11.3	11.1	42
44								9.5	10.7	10.5	10.4	44
46								7.5	9.1	9.9	9.8	46
48									7.4	8.8	9.2	48
50										7.3	8.4	50
52											6.9	52
54											5.6	54
Counter weight(t)	68+25											Counter weight(t)
Parts of line	5	5	4	4	4	3	3	3	2	2	2	Parts of line

LJ Load Chart**Load chart -LJ (Aux. hook, Boom angle 84°) 2/10**

Load chart -LJ (Aux. hook, Boom angle 84°) 2/10												
Jib length (m) Radius (m)	Boom 28m											Jib length (m) Radius (m)
	22	25	28	31	34	37	40	43	46	49	52	
12	58.8											12
14	51.1	50.4	49.6	48.4								14
16	44.4	44.6	44.0	43.3	42.0	36.5						16
18	37.3	37.5	38.6	38.6	38.2	36.3	31.8	27.8	24.4			18
20	32.1	32.3	33.2	33.2	33.2	33.1	31.5	27.5	24.1	21.3	18.8	20
22	28.1	28.3	29.1	29.0	29.0	28.9	28.8	27.2	23.8	21.0	18.5	22
24	25.0	25.1	25.8	25.7	25.7	25.6	25.5	25.4	23.5	20.7	18.1	24
26	20.3	22.5	23.2	23.1	23.1	23.0	22.8	22.7	22.6	20.3	17.8	26
28		20.3	21.0	20.9	20.9	20.8	20.7	20.5	20.4	20.0	17.5	28
30			19.1	19.1	19.0	18.9	18.8	18.7	18.5	18.4	17.1	30
32				17.5	17.4	17.3	17.2	17.1	17.0	16.8	16.7	32
34				14.6	16.1	16.0	15.9	15.8	15.6	15.5	15.3	34
36					14.3	14.8	14.7	14.6	14.4	14.3	14.2	36
38						13.7	13.6	13.5	13.4	13.2	13.1	38
40						11.0	12.7	12.6	12.5	12.3	12.2	40
42							10.9	11.8	11.6	11.5	11.4	42
44								10.5	10.9	10.8	10.6	44
46								8.4	10.1	10.1	10.0	46
48									8.3	9.5	9.4	48
50										8.1	8.8	50
52										6.4	7.8	52
54											6.3	54
Counter weight(t) Parts of line	68+25											Counter weight(t) Parts of line
	5	4	4	4	4	3	3	3	2	2	2	

LJ Load Chart

Load chart -LJ (Aux. hook, Boom angle 84°) 3/10												
Jib length (m) Radius (m)	Boom 31m											Jib length (m) Radius (m)
	22	25	28	31	34	37	40	43	46	49	52	
12	56.7											12
14	49.7	48.9	48.0	46.5								14
16	43.9	43.2	42.6	42.1	40.4	35.3						16
18	38.3	38.5	38.3	37.9	37.2	35.1	30.8	27.0				18
20	32.8	33.0	34.0	33.9	33.7	33.2	30.5	26.8	23.6	20.8	18.4	20
22	28.7	28.8	29.7	29.6	29.6	29.5	29.4	26.5	23.3	20.5	18.1	22
24	25.4	25.5	26.3	26.2	26.2	26.1	26.0	25.9	23.0	20.2	17.8	24
26	22.6	22.9	23.6	23.5	23.4	23.4	23.2	23.2	22.7	19.9	17.5	26
28		20.7	21.3	21.2	21.2	21.1	21.0	20.9	20.8	19.6	17.2	28
30			19.4	19.3	19.3	19.2	19.1	19.0	18.9	18.7	16.9	30
32			16.0	17.7	17.7	17.6	17.4	17.4	17.3	17.1	16.6	32
34				15.9	16.3	16.2	16.1	16.0	15.9	15.7	15.6	34
36					15.1	15.0	14.8	14.7	14.6	14.5	14.4	36
38					11.9	13.9	13.8	13.7	13.6	13.4	13.3	38
40						12.0	12.8	12.7	12.6	12.5	12.4	40
42							11.8	11.9	11.8	11.6	11.5	42
44								11.1	11.0	10.9	10.8	44
46								9.2	10.3	10.2	10.1	46
48									9.0	9.6	9.5	48
50										8.8	8.9	50
52										7.0	8.4	52
54											7.0	54
Counter weight(t) Parts of line	68+25											Counter weight(t) Parts of line
	5	4	4	4	3	3	3	2	2	2	2	

LJ Load Chart

Load chart -LJ (Aux. hook, Boom angle 84°) 4/10												
Jib length (m) Radius (m)	Boom 34m											Jib length (m) Radius (m)
	22	25	28	31	34	37	40	43	46	49	52	
12	55.1											12
14	48.5	47.6	46.6									14
16	42.9	42.1	41.4	40.8	38.7	33.9						16
18	38.1	37.6	37.2	36.8	36.2	33.7	29.7	26.2				18
20	33.6	33.8	33.7	33.3	32.8	32.3	29.5	25.9	22.9	20.3		20
22	29.3	29.4	30.3	30.2	30.0	29.4	29.1	25.7	22.7	20.0	17.7	22
24	25.9	26.0	26.8	26.7	26.7	26.6	26.5	25.4	22.4	19.8	17.4	24
26	23.2	23.3	23.9	23.9	23.8	23.8	23.6	23.6	22.1	19.5	17.1	26
28		21.0	21.6	21.5	21.5	21.4	21.3	21.2	21.1	19.2	16.8	28
30			19.7	19.6	19.5	19.5	19.3	19.3	19.2	18.9	16.6	30
32			17.4	17.9	17.9	17.8	17.7	17.6	17.5	17.4	16.3	32
34				16.5	16.5	16.4	16.3	16.2	16.1	15.9	15.8	34
36					15.2	15.1	15.0	14.9	14.8	14.7	14.6	36
38					13.0	14.1	13.9	13.8	13.7	13.6	13.5	38
40						12.8	13.0	12.9	12.8	12.6	12.5	40
42							12.1	12.0	11.9	11.8	11.7	42
44							9.9	11.3	11.1	11.0	10.9	44
46								9.9	10.4	10.3	10.2	46
48									9.7	9.7	9.6	48
50									7.6	9.1	9.0	50
52										7.6	8.5	52
54											7.4	54
Counter weight(t) Parts of line	68+25											Counter weight(t) Parts of line
	5	4	4	4	3	3	3	2	2	2	2	

LJ Load Chart

Load chart -LJ (Aux. hook, Boom angle 84°) 5/10												
Boom 37m												Jib length (m)
Jib length (m) Radius (m)	22	25	28	31	34	37	40	43	46	49	52	Radius (m)
14	46.8	46.1	45.0									14
16	41.5	41.2	40.4	39.4	36.9							16
18	37.0	36.9	36.3	35.8	35.1	32.3	28.6	25.3				18
20	33.3	33.1	32.9	32.5	31.9	31.3	28.4	25.1	22.2	19.7		20
22	29.9	30.0	29.9	29.5	29.2	28.7	28.2	24.9	22.0	19.5	17.2	22
24	26.4	26.5	27.2	27.0	26.9	26.4	26.1	24.7	21.7	19.2	17.0	24
26	23.6	23.7	24.3	24.3	24.2	24.2	24.0	23.7	21.5	19.0	16.7	26
28		21.4	22.0	21.9	21.8	21.8	21.6	21.6	21.2	18.7	16.5	28
30		18.5	20.0	19.9	19.8	19.7	19.6	19.5	19.4	18.4	16.2	30
32			18.3	18.2	18.1	18.1	17.9	17.8	17.7	17.6	15.9	32
34				16.7	16.7	16.6	16.5	16.4	16.3	16.1	15.7	34
36					15.4	15.3	15.2	15.1	15.0	14.9	14.8	36
38					14.0	14.2	14.1	14.0	13.9	13.8	13.6	38
40						13.2	13.1	13.0	12.9	12.8	12.7	40
42							12.2	12.1	12.0	11.9	11.8	42
44							10.6	11.4	11.3	11.1	11.0	44
46								10.6	10.5	10.4	10.3	46
48									9.9	9.8	9.7	48
50									8.2	9.2	9.1	50
52										8.2	8.6	52
54											8.0	54
56											6.3	56
Counter weight(t) Parts of line	68+25											Counter weight(t) Parts of line
	4	4	4	3	3	3	3	2	2	2	2	

LJ Load Chart

Load chart -LJ (Aux. hook, Boom angle 84°) 6/10

Load chart -LJ (Aux. hook, Boom angle 84°) 6/10												
Boom 40m												
Jib length (m) Radius (m)	22	25	28	31	34	37	40	43	46	49	52	Jib length (m) Radius (m)
14	45.6	44.5										14
16	40.5	40.0	39.1	38.4	35.1							16
18	36.2	35.9	35.5	34.8	34.1	30.9	27.5					18
20	32.6	32.2	32.2	31.6	31.2	30.5	27.3	24.2	21.5	19.1		20
22	29.7	29.3	29.2	28.8	28.4	28.0	27.1	24.0	21.2	18.9	16.7	22
24	26.9	26.8	26.8	26.5	26.1	25.7	25.5	23.8	21.0	18.7	16.5	24
26	24.0	24.1	24.5	24.2	24.0	23.7	23.5	23.1	20.8	18.4	16.3	26
28		21.7	22.3	22.2	22.2	22.0	21.8	21.5	20.5	18.2	16.0	28
30		19.7	20.3	20.2	20.1	20.0	19.9	19.8	19.6	17.9	15.8	30
32			18.5	18.4	18.4	18.3	18.2	18.1	18.0	17.7	15.5	32
34				17.0	16.9	16.8	16.7	16.6	16.5	16.4	15.3	34
36				14.8	15.6	15.5	15.4	15.3	15.2	15.1	14.9	36
38					14.5	14.4	14.3	14.2	14.1	13.9	13.8	38
40						13.4	13.3	13.2	13.1	12.9	12.8	40
42							12.4	12.3	12.2	12.0	11.9	42
44							11.4	11.5	11.4	11.2	11.1	44
46								10.6	10.7	10.5	10.4	46
48									9.8	9.9	9.8	48
50									8.7	9.1	9.1	50
52										8.3	8.4	52
54											7.7	54
56											6.8	56
Counter weight(t) Parts of line	68+25											Counter weight(t) Parts of line
	4	4	3	3	3	3	3	2	2	2	2	

LJ Load Chart

Load chart -LJ (Aux. hook, Boom angle 84°) 7/10												
Boom 43m												
Jib length (m) Radius (m)	22	25	28	31	34	37	40	43	46	49	52	Jib length (m) Radius (m)
14	44.0	43.3										14
16	39.5	38.8	38.0	37.2								16
18	35.3	34.8	34.5	34.0	33.1	29.4	26.3					18
20	31.9	31.5	31.3	30.9	30.3	29.2	26.1	23.2	20.6			20
22	28.9	28.7	28.5	28.1	27.7	27.2	25.9	23.0	20.5	18.2	16.2	22
24	26.4	26.3	26.1	25.8	25.5	25.1	24.8	22.8	20.2	18.0	16.0	24
26	24.3	24.0	23.9	23.8	23.5	23.2	23.0	22.5	20.0	17.8	15.8	26
28		22.0	22.2	21.9	21.7	21.4	21.3	20.9	19.8	17.6	15.6	28
30		20.0	20.5	20.3	20.2	19.8	19.7	19.4	19.2	17.3	15.3	30
32			18.8	18.7	18.6	18.5	18.3	18.1	17.9	17.1	15.1	32
34				17.2	17.1	17.0	16.9	16.8	16.6	16.3	14.9	34
36				15.8	15.8	15.7	15.6	15.5	15.4	15.2	14.6	36
38					14.5	14.6	14.4	14.3	14.2	14.1	13.9	38
40						13.3	13.4	13.3	13.2	13.1	12.9	40
42						12.1	12.3	12.4	12.3	12.2	12.1	42
44							11.1	11.4	11.4	11.4	11.2	44
46								10.3	10.4	10.5	10.4	46
48								9.3	9.5	9.7	9.6	48
50									8.7	8.9	8.9	50
52										8.2	8.2	52
54											7.6	54
56											6.9	56
Counter weight(t) Parts of line	68+25											Counter weight(t) Parts of line
	4	4	3	3	3	3	2	2	2	2	2	

LJ Load Chart

Load chart -LJ (Aux. hook, Boom angle 84°) 8/10												
Boom 46m												
Jib length (m) Radius (m)	22	25	28	31	34	37	40	43	46	49	52	Jib length (m) Radius (m)
14	42.9	41.8										14
16	38.3	37.7	36.9	35.2								16
18	34.3	34.0	33.5	32.9	31.2	27.9						18
20	31.1	30.8	30.4	30.1	29.5	27.7	24.8	22.2	19.8			20
22	28.4	28.0	27.9	27.4	27.0	26.6	24.6	22.0	19.6	17.5	15.7	22
24	25.8	25.8	25.4	25.3	24.9	24.4	24.2	21.8	19.4	17.3	15.5	24
26	23.7	23.5	23.4	23.3	22.9	22.6	22.3	21.5	19.2	17.1	15.3	26
28	22.0	21.8	21.7	21.5	21.2	21.0	20.6	20.4	18.9	16.9	15.1	28
30		20.3	20.1	19.8	19.6	19.4	19.3	19.0	18.5	16.7	14.8	30
32			18.6	18.4	18.3	18.1	17.9	17.8	17.3	16.5	14.6	32
34				17.2	17.0	16.9	16.8	16.6	16.3	15.7	14.4	34
36				15.4	15.6	15.7	15.6	15.4	15.1	14.7	14.1	36
38					14.0	14.2	14.3	14.2	14.0	13.7	13.3	38
40						12.9	13.1	13.0	13.0	12.7	12.5	40
42						11.6	11.8	11.9	11.9	11.8	11.6	42
44							10.8	10.9	10.9	11.0	10.7	44
46								9.9	10.0	10.1	10.0	46
48								9.1	9.1	9.3	9.2	48
50									8.4	8.5	8.5	50
52										7.8	7.8	52
54										7.2	7.2	54
56											6.6	56
Counter weight(t) Parts of line	68+25											Counter weight(t) Parts of line
	4	4	3	3	3	3	2	2	2	2	2	

LJ Load Chart

Load chart -LJ (Aux. hook, Boom angle 84°) 9/10												
Jib length (m) Radius (m)	Boom 49m											Jib length (m) Radius (m)
	22	25	28	31	34	37	40	43	46	49	52	
14	41.5											14
16	37.2	36.6	35.8	33.0								16
18	33.5	33.0	32.6	32.1	29.4	26.4						18
20	30.4	30.0	29.6	29.2	28.7	26.1	23.6	21.1	18.9			20
22	27.8	27.4	27.0	26.8	26.5	25.8	23.3	20.9	18.7	16.8	15.0	22
24	25.3	25.2	25.0	24.5	24.4	23.8	23.0	20.7	18.5	16.7	14.9	24
26	23.4	23.1	22.9	22.8	22.4	22.0	21.8	20.4	18.3	16.5	14.7	26
28	21.5	21.4	21.3	21.0	20.8	20.4	20.2	19.8	18.1	16.3	14.5	28
30		19.8	19.7	19.5	19.3	19.0	18.9	18.5	17.8	16.0	14.3	30
32			18.3	18.1	17.9	17.6	17.5	17.2	16.9	15.8	14.1	32
34			16.8	16.9	16.7	16.6	16.4	16.1	15.8	15.1	13.9	34
36				15.4	15.5	15.4	15.3	15.1	14.7	14.2	13.6	36
38					13.9	14.0	14.0	13.9	13.6	13.3	12.9	38
40						12.7	12.8	12.8	12.7	12.5	12.1	40
42						11.6	11.7	11.7	11.7	11.6	11.3	42
44							10.6	10.8	10.7	10.7	10.5	44
46								9.8	9.9	9.9	9.8	46
48								9.0	9.0	9.1	9.1	48
50									8.3	8.4	8.4	50
52										7.7	7.7	52
54										7.1	7.1	54
56											6.5	56
Counter weight(t) Parts of line	68+25											Counter weight(t) Parts of line
	4	3	3	3	3	2	2	2	2	2	2	

LJ Load Chart**Load chart -LJ (Aux. hook, Boom angle 84°) 10/10**

Load chart -LJ (Aux. hook, Boom angle 84°) 10/10												
Boom 52m												
Jib length (m) Radius (m)	22	25	28	31	34	37	40	43	46	49	52	Jib length (m) Radius (m)
14	40.2											14
16	36.1	35.5	34.1									16
18	32.5	32.1	31.7	30.4	27.5	24.8						18
20	29.6	29.2	28.9	28.5	27.1	24.5	22.3	20.0				20
22	27.1	26.7	26.4	26.0	25.6	24.2	22.0	19.8	17.8	16.1	14.4	22
24	24.8	24.6	24.4	24.0	23.7	23.2	21.7	19.6	17.6	15.9	14.2	24
26	22.9	22.6	22.4	22.2	21.8	21.6	21.2	19.3	17.4	15.7	14.0	26
28	21.1	20.9	20.8	20.5	20.3	20.0	19.7	19.0	17.2	15.5	13.9	28
30		19.4	19.3	19.0	18.8	18.5	18.3	18.0	16.9	15.3	13.7	30
32			17.9	17.7	17.5	17.2	17.2	16.8	16.1	15.0	13.5	32
34			16.3	16.4	16.4	16.1	15.9	15.6	15.1	14.6	13.2	34
36				14.8	14.9	14.8	14.7	14.5	14.0	13.7	13.0	36
38					13.5	13.4	13.5	13.4	13.1	12.8	12.3	38
40					12.2	12.3	12.3	12.3	12.1	11.9	11.5	40
42						11.1	11.3	11.3	11.2	11.1	10.8	42
44							10.3	10.4	10.3	10.2	10.0	44
46							9.4	9.4	9.5	9.5	9.3	46
48								8.6	8.7	8.8	8.7	48
50									8.0	8.1	8.1	50
52										7.4	7.4	52
54										6.8	6.9	54
56											6.3	56
Counter weight(t) Parts of line	68+25											Counter weight(t) Parts of line
	3	3	3	3	3	2	2	2	2	2	2	

LJ Load Chart

Load chart -LJ (Aux. hook, Boom angle 75°) 1/10												
Jib length (m) Radius (m)	Boom 25m											Jib length (m) Radius (m)
	22	25	28	31	34	37	40	43	46	49	52	
20	38.6	38.4										20
22	34.3	34.2	34.0	33.7								22
24	30.8	30.7	30.5	30.3	30.1							24
26	27.5	27.6	27.6	27.4	27.3	27.1	26.9					26
28	24.5	24.6	25.2	25.0	24.9	24.7	24.5	24.3				28
30		22.1	22.7	22.5	22.4	22.3	22.1	22.0	21.5	18.8		30
32		20.0	20.6	20.4	20.3	20.2	20.0	19.9	19.8	18.6	16.2	32
34			18.8	18.7	18.6	18.4	18.3	18.1	18.0	17.8	16.0	34
36				17.2	17.1	16.9	16.8	16.6	16.5	16.3	15.7	36
38				15.8	15.7	15.6	15.4	15.3	15.2	15.0	14.9	38
40					14.6	14.5	14.3	14.2	14.0	13.9	13.8	40
42						13.5	13.3	13.2	13.0	12.9	12.8	42
44						11.8	12.4	12.3	12.2	12.0	11.9	44
46							11.6	11.5	11.4	11.2	11.1	46
48								10.8	10.6	10.5	10.4	48
50								9.2	10.0	9.8	9.7	50
52									9.2	9.3	9.1	52
54										8.7	8.6	54
56											8.1	56
58											7.1	58
Counter weight(t) Parts of line	68+25											Counter weight(t) Parts of line
	3	3	3	3	3	3	2	2	2	2	2	

LJ Load Chart**Load chart -LJ (Aux. hook, Boom angle 75°) 2/10**

Load chart -LJ (Aux. hook, Boom angle 75°) 2/10												
Jib length (m) Radius (m)	Boom 28m											Jib length (m) Radius (m)
	22	25	28	31	34	37	40	43	46	49	52	
20	38.1											20
22	33.9	33.8	33.6									22
24	30.5	30.3	30.1	29.9	29.7							24
26	27.6	27.5	27.3	27.1	26.9	26.8						26
28	25.2	25.1	24.9	24.7	24.6	24.4	24.2	24.0				28
30	22.9	23.0	22.9	22.7	22.5	22.4	22.2	22.0	21.2			30
32		20.8	21.1	20.9	20.8	20.6	20.4	20.3	20.1	18.3	16.0	32
34			19.5	19.4	19.3	19.1	18.9	18.8	18.6	18.1	15.8	34
36			17.9	17.8	17.7	17.6	17.5	17.4	17.2	17.0	15.6	36
38				16.4	16.3	16.2	16.1	16.0	15.8	15.7	15.4	38
40					15.1	15.0	14.9	14.8	14.6	14.5	14.3	40
42					14.0	13.9	13.8	13.7	13.6	13.4	13.3	42
44						13.0	12.9	12.7	12.6	12.5	12.3	44
46							12.0	11.9	11.8	11.6	11.5	46
48								11.2	11.0	10.9	10.7	48
50								10.5	10.3	10.2	10.1	50
52									9.7	9.6	9.5	52
54										9.0	8.9	54
56										8.5	8.4	56
58											7.9	58
Counter weight(t) Parts of line	68+25											Counter weight(t) Parts of line
	3	3	3	3	3	2	2	2	2	2	2	

LJ Load Chart

Load chart -LJ (Aux. hook, Boom angle 75°) 3/10												
Jib length (m) Radius (m)	Boom 31m											Jib length (m) Radius (m)
	22	25	28	31	34	37	40	43	46	49	52	
20	37.7											20
22	33.5	33.3										22
24	30.1	29.9	29.7	29.5								24
26	27.3	27.1	27.0	26.7	26.6	26.4						26
28	24.9	24.8	24.6	24.4	24.2	24.0	23.8					28
30	22.9	22.8	22.6	22.4	22.2	22.1	21.8	21.7	20.8			30
32		21.0	20.9	20.7	20.5	20.3	20.1	20.0	19.8	18.0		32
34		19.5	19.3	19.1	19.0	18.8	18.6	18.5	18.3	17.9	15.6	34
36			18.0	17.8	17.7	17.5	17.3	17.2	17.0	16.8	15.4	36
38				16.6	16.5	16.4	16.1	16.0	15.8	15.6	15.2	38
40				15.5	15.4	15.3	15.1	15.0	14.8	14.6	14.4	40
42					14.4	14.3	14.2	14.0	13.9	13.6	13.5	42
44						13.4	13.2	13.1	13.0	12.8	12.7	44
46							12.3	12.2	12.1	12.0	11.9	46
48							11.5	11.5	11.3	11.2	11.1	48
50								10.7	10.6	10.5	10.4	50
52									10.0	9.8	9.7	52
54									9.4	9.3	9.1	54
56										8.7	8.6	56
58											8.1	58
60											7.7	60
Counter weight(t) Parts of line	68+25											Counter weight(t) Parts of line
	3	3	3	3	2	2	2	2	2	2	2	

LJ Load Chart**Load chart -LJ (Aux. hook, Boom angle 75°) 4/10**

Load chart -LJ (Aux. hook, Boom angle 75°) 4/10												
Jib length (m) Radius (m)	Boom 34m											Jib length (m) Radius (m)
	22	25	28	31	34	37	40	43	46	49	52	
22	33.1	32.9										22
24	29.7	29.6	29.4									24
26	27.0	26.8	26.6	26.4	26.2							26
28	24.6	24.5	24.3	24.1	23.9	23.7	23.5					28
30	22.6	22.5	22.3	22.1	21.9	21.8	21.5	21.4				30
32	20.8	20.8	20.6	20.4	20.2	20.1	19.8	19.7	19.5	17.7		32
34		19.2	19.1	18.9	18.7	18.6	18.4	18.2	18.0	17.5	15.3	34
36			17.8	17.6	17.4	17.3	17.1	16.9	16.7	16.5	15.1	36
38				16.4	16.3	16.1	15.9	15.8	15.6	15.4	15.0	38
40				15.3	15.2	15.1	14.9	14.7	14.6	14.3	14.2	40
42					14.3	14.2	13.9	13.8	13.6	13.4	13.3	42
44						13.3	13.1	13.0	12.8	12.6	12.4	44
46						12.5	12.3	12.2	12.1	11.8	11.7	46
48							11.6	11.5	11.4	11.2	11.0	48
50								10.9	10.7	10.5	10.4	50
52								10.3	10.1	9.9	9.8	52
54									9.6	9.4	9.3	54
56										8.9	8.8	56
58										8.4	8.3	58
60											7.8	60
Counter weight(t) Parts of line	68+25											Counter weight(t) Parts of line
	3	3	3	2	2	2	2	2	2	2	2	

LJ Load Chart

Load chart -LJ (Aux. hook, Boom angle 75°) 5/10												
Boom 37m												
Jib length (m) Radius (m)	22	25	28	31	34	37	40	43	46	49	52	Jib length (m) Radius (m)
22	32.6											22
24	29.3	29.2	28.9									24
26	26.6	26.4	26.2	26.0								26
28	24.3	24.1	23.9	23.7	23.5	23.3						28
30	22.3	22.2	22.0	21.7	21.6	21.4	21.2					30
32	20.6	20.5	20.3	20.1	19.9	19.7	19.5	19.3	19.2			32
34		19.0	18.8	18.6	18.5	18.3	18.0	17.9	17.7	17.2	15.1	34
36			17.5	17.3	17.2	17.0	16.8	16.6	16.4	16.2	14.9	36
38			16.3	16.1	16.0	15.9	15.6	15.5	15.3	15.1	14.7	38
40				15.1	15.0	14.8	14.6	14.5	14.3	14.1	13.9	40
42					14.1	13.9	13.7	13.6	13.4	13.2	13.0	42
44					13.2	13.1	12.9	12.7	12.6	12.4	12.2	44
46						12.3	12.1	12.0	11.8	11.6	11.5	46
48							11.4	11.3	11.1	10.9	10.8	48
50							10.8	10.7	10.5	10.3	10.2	50
52								10.1	9.9	9.7	9.6	52
54									9.4	9.2	9.1	54
56									8.9	8.7	8.6	56
58										8.3	8.1	58
60											7.7	60
Counter weight(t) Parts of line	68+25											Counter weight(t) Parts of line
	3	3	3	2	2	2	2	2	2	2	2	

LJ Load Chart

Load chart -LJ (Aux. hook, Boom angle 75°) 6/10

Load chart -LJ (Aux. hook, Boom angle 75°) 6/10												
Boom 40m												
Jib length (m) Radius (m)	22	25	28	31	34	37	40	43	46	49	52	Jib length (m) Radius (m)
22	32.1											22
24	28.9	28.7										24
26	26.2	26.0	25.8	25.6								26
28	23.9	23.8	23.6	23.3	23.1							28
30	22.0	21.8	21.6	21.4	21.2	21.1	20.8					30
32	20.3	20.2	20.0	19.7	19.6	19.4	19.2	19.0				32
34		18.7	18.5	18.3	18.1	18.0	17.7	17.6	17.4	16.8		34
36		17.4	17.2	17.0	16.9	16.7	16.5	16.3	16.1	15.9	14.6	36
38			16.1	15.9	15.7	15.6	15.4	15.2	15.0	14.8	14.4	38
40				14.9	14.7	14.6	14.4	14.2	14.0	13.8	13.6	40
42				13.9	13.8	13.7	13.5	13.3	13.1	12.9	12.8	42
44					13.0	12.9	12.6	12.5	12.3	12.1	12.0	44
46						12.1	11.9	11.8	11.6	11.4	11.2	46
48						11.4	11.2	11.1	10.9	10.7	10.6	48
50							10.6	10.5	10.3	10.1	10.0	50
52								9.9	9.7	9.5	9.4	52
54									9.2	9.0	8.9	54
56									8.7	8.5	8.4	56
58										8.1	7.9	58
60											7.5	60
62											7.1	62
Counter weight(t) Parts of line	68+25											Counter weight(t) Parts of line
	3	3	2	2	2	2	2	2	2	2	2	

LJ Load Chart

Load chart -LJ (Aux. hook, Boom angle 75°) 7/10												
Boom 43m												
Jib length (m) Radius (m)	22	25	28	31	34	37	40	43	46	49	52	Jib length (m) Radius (m)
24	28.4	28.2										24
26	25.8	25.6	25.4									26
28	23.5	23.4	23.2	22.9	22.7							28
30	21.6	21.5	21.3	21.0	20.9	20.7						30
32	19.9	19.8	19.6	19.4	19.2	19.1	18.8	18.6				32
34	18.5	18.4	18.2	18.0	17.8	17.6	17.4	17.2	17.0			34
36		17.1	16.9	16.7	16.6	16.4	16.2	16.0	15.8	15.6	14.2	36
38			15.8	15.6	15.5	15.3	15.1	14.9	14.7	14.5	14.1	38
40			14.8	14.6	14.5	14.3	14.1	13.9	13.7	13.5	13.3	40
42				13.7	13.6	13.4	13.2	13.0	12.9	12.6	12.5	42
44					12.8	12.6	12.4	12.2	12.1	11.8	11.7	44
46					12.0	11.9	11.7	11.5	11.4	11.1	11.0	46
48						11.2	11.0	10.9	10.7	10.5	10.3	48
50							10.4	10.2	10.1	9.9	9.7	50
52								9.7	9.5	9.3	9.2	52
54								9.2	9.0	8.8	8.7	54
56									8.5	8.3	8.2	56
58										7.9	7.7	58
60										7.5	7.3	60
62											6.9	62
Counter weight(t) Parts of line	68+25											Counter weight(t) Parts of line
	3	3	2	2	2	2	2	2	2	2	2	

LJ Load Chart

Load chart -LJ (Aux. hook, Boom angle 75°) 8/10												
Boom 46m												
Jib length (m) Radius (m)	22	25	28	31	34	37	40	43	46	49	52	Jib length (m) Radius (m)
24	27.9											24
26	25.4	25.2	24.9									26
28	23.2	23.0	22.8	22.5								28
30	21.3	21.1	20.9	20.7	20.5	20.2						30
32	19.6	19.5	19.3	19.1	18.9	18.7	18.4					32
34	18.2	18.1	17.9	17.7	17.5	17.3	17.1	16.9	16.6			34
36		16.8	16.7	16.4	16.3	16.1	15.9	15.7	15.5	15.2		36
38		15.7	15.6	15.3	15.2	15.0	14.8	14.6	14.4	14.2	13.7	38
40			14.5	14.3	14.2	14.0	13.8	13.6	13.5	13.2	13.1	40
42				13.5	13.3	13.2	12.9	12.8	12.6	12.4	12.2	42
44					12.5	12.4	12.1	12.0	11.8	11.6	11.4	44
46					11.8	11.6	11.4	11.3	11.1	10.9	10.7	46
48						11.0	10.8	10.6	10.5	10.2	10.1	48
50							10.2	10.0	9.9	9.7	9.5	50
52								9.6	9.5	9.3	9.1	52
54									9.0	8.8	8.6	54
56										8.3	8.1	56
58											7.9	58
60												60
62												62
64												64
Counter weight(t) Parts of line	68+25											Counter weight(t) Parts of line
	3	2	2	2	2	2	2	2	2	2	2	

LJ Load Chart

Load chart -LJ (Aux. hook, Boom angle 75°) 9/10												
Jib length (m) Radius (m)	Boom 49m											Jib length (m) Radius (m)
	22	25	28	31	34	37	40	43	46	49	52	
26	24.9	24.6										26
28	22.7	22.6	22.3									28
30	20.9	20.7	20.5	20.3	20.0							30
32	19.3	19.2	19.0	18.7	18.5	18.3	17.9					32
34	17.9	17.8	17.6	17.3	17.2	17.0	16.7	16.4				34
36	16.6	16.5	16.3	16.1	15.9	15.8	15.5	15.3	15.1	14.7		36
38		15.4	15.3	15.0	14.9	14.7	14.5	14.3	14.1	13.8	13.3	38
40			14.3	14.1	13.9	13.7	13.5	13.3	13.2	12.9	12.7	40
42				13.2	13.1	12.9	12.7	12.5	12.3	12.1	11.9	42
44				12.4	12.3	12.1	11.9	11.7	11.5	11.3	11.1	44
46					11.5	11.4	11.2	11.0	10.9	10.6	10.5	46
48						10.7	10.5	10.4	10.2	10.0	9.8	48
50						10.1	9.9	9.8	9.6	9.4	9.3	50
52							9.4	9.3	9.1	8.9	8.7	52
54								8.8	8.6	8.4	8.2	54
56								8.3	8.1	7.9	7.8	56
58									7.7	7.5	7.4	58
60										7.1	7.0	60
62										6.7	6.6	62
64											6.2	64
Counter weight(t) Parts of line	68+25											Counter weight(t) Parts of line
	2	2	2	2	2	2	2	2	2	2	1	

LJ Load Chart**Load chart -LJ (Aux. hook, Boom angle 75°) 10/10**

Load chart -LJ (Aux. hook, Boom angle 75°) 10/10												
		Boom 52m										
Jib length (m) Radius (m)	22	25	28	31	34	37	40	43	46	49	52	Jib length (m) Radius (m)
26	24.2											26
28	22.3	22.1	21.7									28
30	20.5	20.3	20.1	19.7								30
32	18.9	18.8	18.6	18.3	18.0	17.7						32
34	17.5	17.4	17.2	17.0	16.8	16.6	16.2	15.9				34
36	16.3	16.2	16.0	15.8	15.6	15.4	15.1	14.9	14.5			36
38		15.1	15.0	14.7	14.6	14.4	14.1	13.9	13.6	13.3	12.8	38
40			14.0	13.8	13.6	13.4	13.2	13.0	12.8	12.5	12.2	40
42			13.1	12.9	12.8	12.6	12.4	12.2	12.0	11.7	11.5	42
44				12.1	12.0	11.8	11.6	11.4	11.3	11.0	10.8	44
46					11.3	11.1	10.9	10.8	10.6	10.3	10.2	46
48					10.6	10.5	10.3	10.1	10.0	9.7	9.6	48
50						9.9	9.7	9.6	9.4	9.2	9.0	50
52							9.2	9.0	8.9	8.6	8.5	52
54							8.7	8.5	8.4	8.2	8.0	54
56								8.1	7.9	7.7	7.6	56
58									7.5	7.3	7.1	58
60										6.9	6.7	60
62										6.5	6.4	62
64											6.0	64
Counter weight(t) Parts of line	68+25											Counter weight(t) Parts of line
	2	2	2	2	2	2	2	2	2	1	1	

LJ Load Chart

Load chart -LJ (Aux. hook, Boom angle 65°) 1/10												
Boom 25m												
Jib length (m) Radius (m)	22	25	28	31	34	37	40	43	46	49	52	Jib length (m) Radius (m)
26	26.6											26
28	24.3	24.1										28
30	22.3	22.1	22.0									30
32	20.6	20.5	20.3	20.0								32
34		19.0	18.8	18.6	18.4							34
36		17.6	17.5	17.3	17.1	17.0	16.7					36
38			16.3	16.1	16.0	15.8	15.6	15.4				38
40				15.1	15.0	14.8	14.6	14.4	14.2			40
42				14.1	14.0	13.9	13.7	13.5	13.3	13.1		42
44					13.2	13.0	12.8	12.7	12.5	12.3	12.1	44
46						12.3	12.1	11.9	11.8	11.6	11.4	46
48						11.6	11.4	11.3	11.1	10.9	10.7	48
50							10.8	10.6	10.5	10.3	10.1	50
52								10.1	9.9	9.7	9.5	52
54								9.5	9.4	9.2	9.0	54
56									8.9	8.7	8.5	56
58										8.2	8.1	58
60										7.8	7.7	60
62											7.3	62
Counter weight(t)	68+25											Counter weight(t)
Parts of line	2	2	2	2	2	2	2	2	2	1	1	Parts of line

LJ Load Chart**Load chart -LJ (Aux. hook, Boom angle 65°) 2/10**

Load chart -LJ (Aux. hook, Boom angle 65°) 2/10												
Boom 28m												
Jib length (m) Radius (m)	22	25	28	31	34	37	40	43	46	49	52	Jib length (m) Radius (m)
28	23.8											28
30	21.8	21.7										30
32	20.1	20.0	19.8	19.6								32
34	18.7	18.6	18.4	18.1	18.0							34
36		17.3	17.1	16.9	16.7	16.5						36
38		16.1	16.0	15.7	15.6	15.4	15.2					38
40			14.9	14.7	14.6	14.4	14.2	14.0				40
42				13.8	13.7	13.5	13.3	13.2	13.0			42
44					12.9	12.7	12.5	12.4	12.2	11.9	11.8	44
46					12.1	12.0	11.8	11.6	11.5	11.2	11.1	46
48						11.3	11.1	11.0	10.8	10.6	10.4	48
50							10.5	10.3	10.2	10.0	9.8	50
52							9.9	9.8	9.6	9.4	9.2	52
54								9.2	9.1	8.9	8.7	54
56									8.6	8.4	8.3	56
58									8.2	8.0	7.8	58
60										7.5	7.4	60
62											7.0	62
64											6.6	64
Counter weight(t) Parts of line	68+25											Counter weight(t) Parts of line
	2	2	2	2	2	2	2	2	1	1	1	

LJ Load Chart

Load chart -LJ (Aux. hook, Boom angle 65°) 3/10												
Boom 31m												
Jib length (m) Radius (m)	22	25	28	31	34	37	40	43	46	49	52	Jib length (m) Radius (m)
30	21.3	21.2										30
32	19.7	19.5	19.3									32
34	18.2	18.1	17.9	17.7								34
36	17.0	16.9	16.7	16.4	16.3							36
38		15.7	15.6	15.3	15.2	15.0						38
40			14.6	14.4	14.2	14.0	13.8					40
42			13.7	13.5	13.3	13.2	12.9	12.8	12.6			42
44				12.7	12.5	12.4	12.1	12.0	11.8	11.6		44
46					11.8	11.6	11.4	11.3	11.1	10.9	10.7	46
48					11.1	11.0	10.8	10.6	10.4	10.2	10.1	48
50						10.4	10.2	10.0	9.9	9.6	9.5	50
52							9.6	9.5	9.3	9.1	8.9	52
54								9.0	8.8	8.6	8.4	54
56								8.5	8.3	8.1	8.0	56
58									7.9	7.7	7.5	58
60										7.3	7.1	60
62										6.9	6.8	62
64											6.4	64
Counter weight(t)	68+25											Counter weight(t)
Parts of line	2	2	2	2	2	2	2	1	1	1	1	Parts of line

LJ Load Chart**Load chart -LJ (Aux. hook, Boom angle 65°) 4/10**

Load chart -LJ (Aux. hook, Boom angle 65°) 4/10												
Boom 34m												
Jib length (m) Radius (m)	22	25	28	31	34	37	40	43	46	49	52	Jib length (m) Radius (m)
30	20.9											30
32	19.3	19.1										32
34	17.9	17.7	17.5									34
36	16.6	16.5	16.3	16.0								36
38		15.4	15.2	15.0	14.8	14.6						38
40		14.4	14.2	14.0	13.9	13.7	13.4					40
42			13.4	13.1	13.0	12.8	12.6	12.4				42
44				12.3	12.2	12.0	11.8	11.6	11.5			44
46				11.6	11.5	11.3	11.1	10.9	10.8	10.5		46
48					10.8	10.7	10.5	10.3	10.1	9.9	9.7	48
50						10.1	9.9	9.7	9.6	9.3	9.2	50
52						9.5	9.3	9.2	9.0	8.8	8.6	52
54							8.8	8.7	8.5	8.3	8.1	54
56								8.2	8.1	7.8	7.7	56
58								7.8	7.6	7.4	7.3	58
60									7.2	7.0	6.9	60
62										6.7	6.5	62
64											6.2	64
66											5.8	66
Counter weight(t) Parts of line	68+25											Counter weight(t) Parts of line
	2	2	2	2	2	2	1	1	1	1	1	

LJ Load Chart

Load chart -LJ (Aux. hook, Boom angle 65°) 5/10												
Boom 37m												
Jib length (m) Radius (m)	22	25	28	31	34	37	40	43	46	49	52	Jib length (m) Radius (m)
32	18.8											32
34	17.4	17.2										34
36	16.2	16.0	15.8	15.6								36
38	15.1	15.0	14.8	14.5	14.4							38
40		14.0	13.8	13.6	13.4	13.2						40
42			13.0	12.7	12.6	12.4	12.2					42
44			12.2	12.0	11.8	11.7	11.4	11.2				44
46				11.3	11.1	11.0	10.7	10.6	10.4			46
48					10.5	10.3	10.1	9.9	9.8	9.5	9.4	48
50					9.9	9.8	9.5	9.4	9.2	9.0	8.8	50
52						9.2	9.0	8.9	8.7	8.4	8.3	52
54							8.5	8.4	8.2	8.0	7.8	54
56							8.1	7.9	7.8	7.5	7.4	56
58								7.5	7.3	7.1	7.0	58
60									7.0	6.7	6.6	60
62									6.6	6.4	6.2	62
64										6.0	5.9	64
66											5.6	66
68											5.3	68
Counter weight(t)	68+25											Counter weight(t)
Parts of line	2	2	2	2	2	2	2	1	1	1	1	Parts of line

LJ Load Chart**Load chart -LJ (Aux. hook, Boom angle 65°) 6/10**

Load chart -LJ (Aux. hook, Boom angle 65°) 6/10												
Jib length (m) Radius (m)	Boom 40m											Jib length (m) Radius (m)
	22	25	28	31	34	37	40	43	46	49	52	
32	18.2											32
34	16.9	16.7										34
36	15.7	15.6	15.4									36
38	14.7	14.5	14.3	14.1								38
40	13.7	13.6	13.4	13.2	13.0							40
42		12.8	12.6	12.3	12.2	12.0						42
44			11.8	11.6	11.4	11.3	11.0	10.8				44
46			11.1	10.9	10.8	10.6	10.3	10.2	10.0			46
48				10.3	10.2	10.0	9.7	9.6	9.4	9.1		48
50					9.6	9.4	9.2	9.0	8.8	8.6	8.4	50
52						8.9	8.7	8.5	8.3	8.1	7.9	52
54						8.4	8.2	8.1	7.9	7.6	7.5	54
56							7.8	7.6	7.4	7.2	7.0	56
58								7.2	7.0	6.8	6.7	58
60								6.8	6.7	6.4	6.3	60
62									6.3	6.1	5.9	62
64										5.8	5.6	64
66										5.4	5.3	66
68											5.0	68
Counter weight(t) Parts of line	68+25											Counter weight(t) Parts of line
	2	2	2	2	1	1	1	1	1	1	1	

LJ Load Chart

Load chart -LJ (Aux. hook, Boom angle 65°) 7/10												
Boom 43m												
Jib length (m) Radius (m)	22	25	28	31	34	37	40	43	46	49	52	Jib length (m) Radius (m)
34	16.4											34
36	15.2	15.1										36
38	14.2	14.1	13.9									38
40	13.3	13.2	13.0	12.7	12.5							40
42		12.4	12.2	11.9	11.7	11.6						42
44		11.6	11.4	11.2	11.0	10.8	10.6					44
46			10.8	10.5	10.4	10.2	9.9	9.8				46
48				9.9	9.8	9.6	9.4	9.2	9.0			48
50				9.4	9.2	9.1	8.8	8.7	8.5	8.2		50
52					8.7	8.6	8.3	8.2	8.0	7.7	7.6	52
54						8.1	7.9	7.7	7.5	7.3	7.1	54
56						7.6	7.4	7.3	7.1	6.9	6.7	56
58							7.0	6.9	6.7	6.5	6.3	58
60								6.5	6.4	6.1	6.0	60
62									6.0	5.8	5.6	62
64									5.7	5.5	5.3	64
66										5.2	5.0	66
68											4.7	68
70											4.5	70
Counter weight(t)	68+25											Counter weight(t)
Parts of line	2	2	2	1	1	1	1	1	1	1	1	Parts of line

LJ Load Chart**Load chart -LJ (Aux. hook, Boom angle 65°) 8/10**

Load chart -LJ (Aux. hook, Boom angle 65°) 8/10												
Boom 46m												
Jib length (m) Radius (m)	22	25	28	31	34	37	40	43	46	49	52	Jib length (m) Radius (m)
36	14.8											36
38	13.8	13.6	13.4									38
40	12.9	12.8	12.6	12.3								40
42	12.1	12.0	11.8	11.5	11.3							42
44		11.3	11.1	10.8	10.6	10.4						44
46			10.4	10.2	10.0	9.8	9.6					46
48			9.8	9.6	9.4	9.2	9.0	8.8				48
50				9.0	8.9	8.7	8.5	8.3	8.1	7.8		50
52					8.4	8.2	8.0	7.8	7.6	7.4	7.2	52
54					7.9	7.8	7.5	7.4	7.2	6.9	6.8	54
56						7.4	7.1	7.0	6.8	6.5	6.4	56
58							6.7	6.6	6.4	6.2	6.0	58
60							6.4	6.2	6.1	5.8	5.7	60
62								5.9	5.7	5.5	5.3	62
64									5.4	5.2	5.0	64
66									5.1	4.9	4.7	66
68										4.6	4.5	68
70											4.2	70
Counter weight(t) Parts of line	68+25											Counter weight(t) Parts of line
	2	2	1	1	1	1	1	1	1	1	1	

LJ Load Chart

Load chart -LJ (Aux. hook, Boom angle 65°) 9/10												
Boom 49m												Jib length (m)
Jib length (m) Radius (m)	22	25	28	31	34	37	40	43	46	49	52	Radius (m)
36	14.3											36
38	13.3	13.1										38
40	12.5	12.3	12.1									40
42	11.7	11.5	11.3	11.0								42
44	10.9	10.8	10.6	10.4	10.2							44
46		10.2	10.0	9.8	9.6	9.4	9.1					46
48			9.4	9.2	9.0	8.8	8.6	8.4				48
50				8.7	8.5	8.3	8.1	7.9	7.7			50
52				8.2	8.0	7.9	7.6	7.4	7.2	7.0		52
54					7.6	7.4	7.2	7.0	6.8	6.6	6.4	54
56						7.0	6.8	6.6	6.4	6.2	6.0	56
58						6.6	6.4	6.2	6.1	5.8	5.6	58
60							6.1	5.9	5.7	5.5	5.3	60
62								5.6	5.4	5.2	5.0	62
64								5.3	5.1	4.9	4.7	64
66									4.8	4.6	4.4	66
68										4.3	4.2	68
70										4.1	3.9	70
72											3.7	72
Counter weight(t)	68+25											Counter weight(t)
Parts of line	2	1	1	1	1	1	1	1	1	1	1	Parts of line

LJ Load Chart**Load chart -LJ (Aux. hook, Boom angle 65°) 10/10**

Load chart -LJ (Aux. hook, Boom angle 65°) 10/10												
Boom 52m												
Jib length (m) Radius (m)	22	25	28	31	34	37	40	43	46	49	52	Jib length (m) Radius (m)
38	12.8											38
40	12.0	11.8										40
42	11.2	11.1	10.9									42
44	10.5	10.4	10.2	9.9	9.7							44
46		9.8	9.6	9.3	9.2	9.0						46
48		9.2	9.0	8.8	8.6	8.4	8.1					48
50			8.5	8.3	8.1	7.9	7.7	7.5				50
52				7.8	7.7	7.5	7.2	7.0	6.8			52
54				7.4	7.2	7.1	6.8	6.6	6.4	6.2		54
56					6.8	6.7	6.4	6.3	6.1	5.8	5.6	56
58						6.3	6.1	5.9	5.7	5.5	5.3	58
60							5.7	5.6	5.4	5.1	5.0	60
62							5.4	5.3	5.1	4.8	4.7	62
64								5.0	4.8	4.6	4.4	64
66									4.5	4.3	4.1	66
68									4.3	4.0	3.9	68
70										3.8	3.6	70
72											3.4	72
74											3.2	74
Counter weight(t) Parts of line	68+25											Counter weight(t) Parts of line
	1	1	1	1	1	1	1	1	1	1	1	



Zhejiang Sany Equipment Co.,LTD

SANY Crawler Crane Industrial Park, No. 2188 Daishan Road, Wuxing District, Huzhou City,
Zhejiang Province, P. R. China Zip 313028
Consulting sanycrane@sanygroup.com (Crane BU) / crd@sany.com.cn (IHQ)
After-sales Service 0086-400 6098 318

Reminder:

Any change in the technical parameters and configuration due to product modification or upgrade may occur without prior notice.
The machine in the picture may include additional equipment. This brochure is for reference only, and goods in kind shall prevail.
Copyright at SANY. No part of this brochure may be copied or used for any purpose without written approval from SANY.

© Edited in February 2024

